



FIRE FLY

Brown Manufacturing Group, Inc.
4661 Stafford Ave. S.W.
Wyoming, MI 49548
Phone: 616-249-0200
Fax: 616-249-3211
www.brownmfg.net
customerservice@brownmfg.net

User's Manual

Revision 6





FIRE FLY

Setup Guide

Revision 6

Brown Manufacturing Group, Inc.
4661 Stafford Ave. S.W.
Wyoming, MI 49548
Phone: 616-249-0200
Fax: 616-249-3211
www.brownmfg.net
customerservice@brownmfg.net

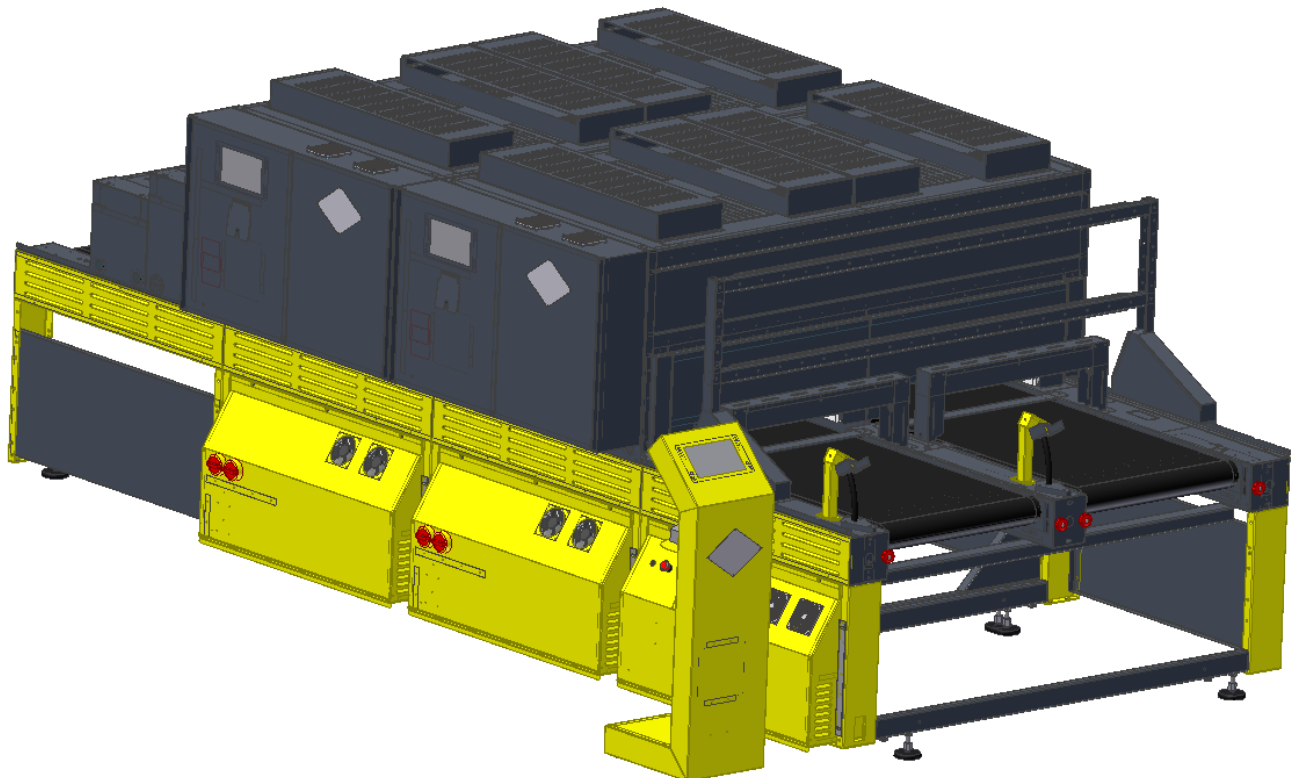

Assembly

A Firefly dryer consists of several modular assemblies which are joined together to create a complete conveyor dryer unit. Common modules are:

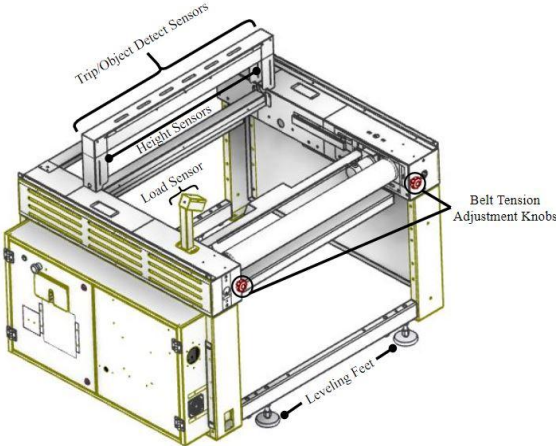

Figure 1: DRIVE ROLLER MODULE

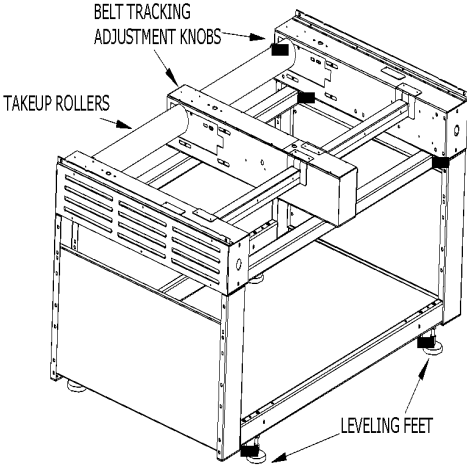

Figure 4: BACK ROLLER MODULE

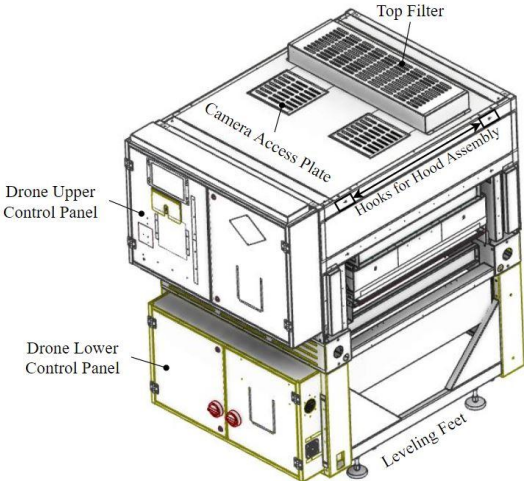

Figure 2: FRONT DRONE HEAT MODULE

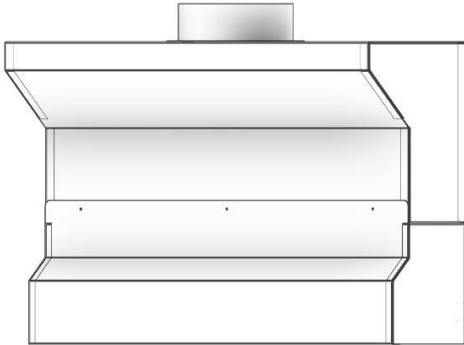

Figure 5: HOOD ASSEMBLY

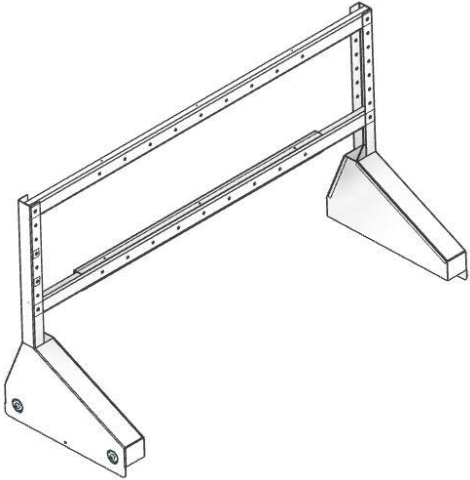
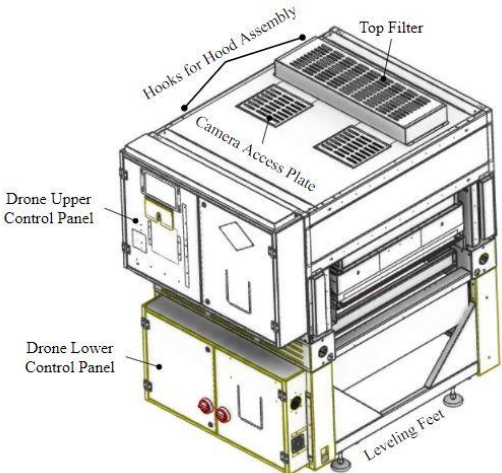

Figure 6: TV STAND

Assembly Step 1: Ensure Adequate Clearance

Before placing the Firefly modules, it is important to ensure adequate clearance will be available for both the main footprint of the machine and maintenance access. Since the Firefly Curing System is a modular system, the main footprint of the machine depends on the exact configuration you purchased. Consult your salesperson for an engineering drawing of your particular system.

Clearance is required around the heat modules in order to open control panel doors, pull out filters, and clean camera boxes. See Figure 7 for specific clearance numbers.

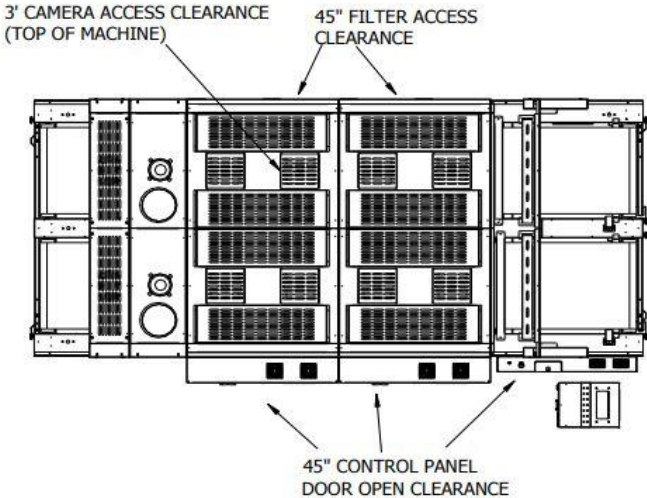

Figure 7: GENERAL CLEARANCES

Clearance is also required for the heat modules to slide on their tracks for maintenance access to the center of the machine. Ensure that nothing blocks the movement of the heat sections front/back as shown in Figure 8.

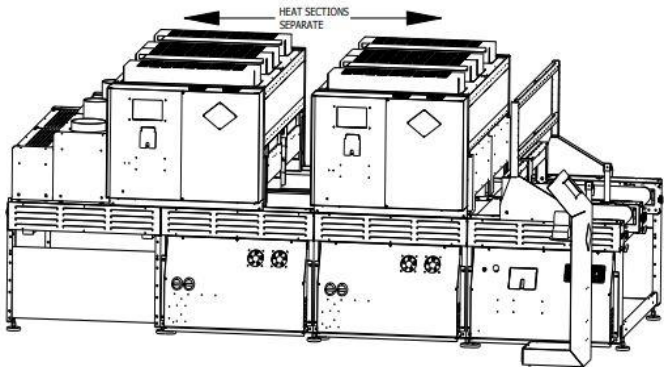

Figure 8: ACCESSING CENTER OF SYSTEM

Assembly Step 2: Identify and Arrange

Using the figures in this manual, identify the modules that shipped with your dryer. Arrange the modules in the location you wish to install the machine in the correct orientations for your system. Below is a standard configuration for a 2 heat section system. As the Firefly system is a modular system, your configuration may be different. Consult with Brown Manufacturing for the exact layout of your system.

Use the leveling legs on each module to bring all the sections to the same height and level. Shift the modules as necessary to create a single, straight frame.

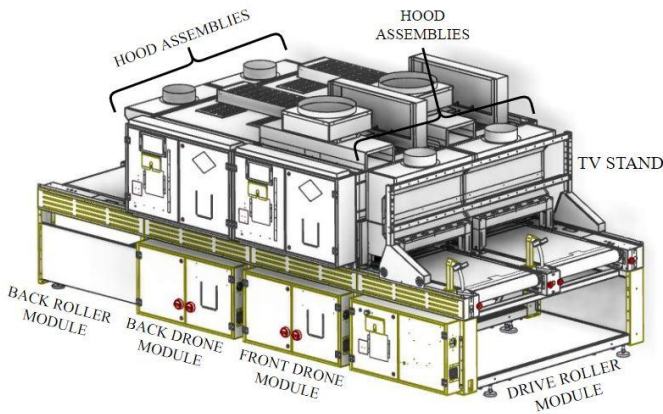

Figure 9: STANDARD MODULE ARRANGEMENT

Assembly Step 3: Connect Modules

Remove the cover grills from the frames of each section. Bolt each module to each adjoining module using the connection holes at the end of each frame.

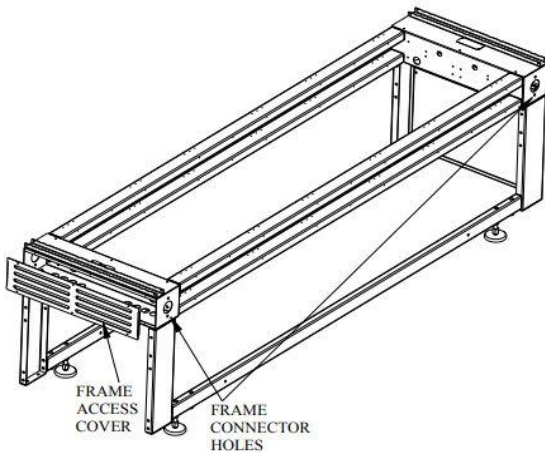

Figure 10: FRAME CONNECTIONS

Assembly Step 4: Mount Accessories

Depending on the exact configuration of your system, you may have to locate and set into position some or all of the following accessories:

- Load Detect Sensor(s)
- Scanners (Mount on scanner stands)
- Height Sensors
- TV (mounts on TV stand –Figure 9)

Assembly Step 5: Install Belts

First, loosen the Belt Tracking Knobs (Figure 11) on both the front and rear of the machine. Slide the rollers as far back as they will go.

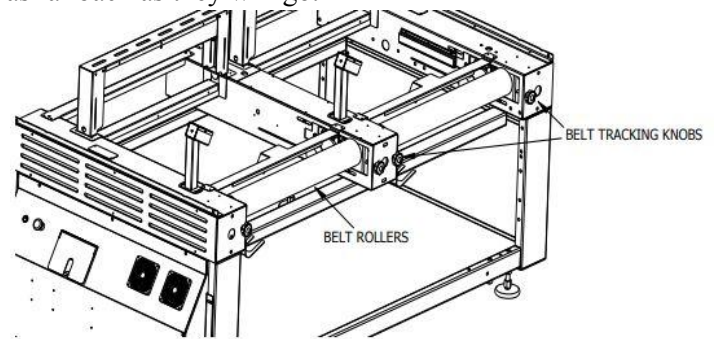

Figure 11: LOOSENING BELT TENSION

Next, run the belt through the body of the machine. The belt may have a flap covering the seam. Make sure when the seam is on the top side of the roller, the attached side of the flap is on top and moving in the direction of the belt (Figure 12)

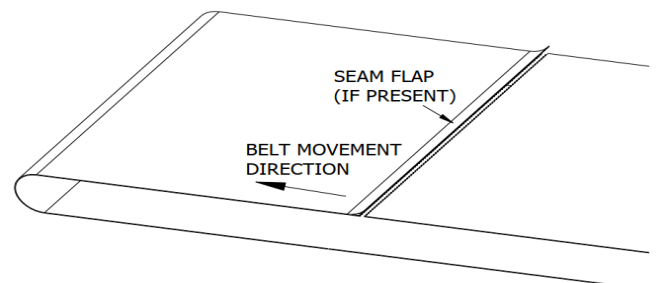

Figure 12: SEAM FLAP ORIENTATION

Each end of the belt has a row of eyelets. Line up eyelets together, and push the connector pin through (Figure 13).

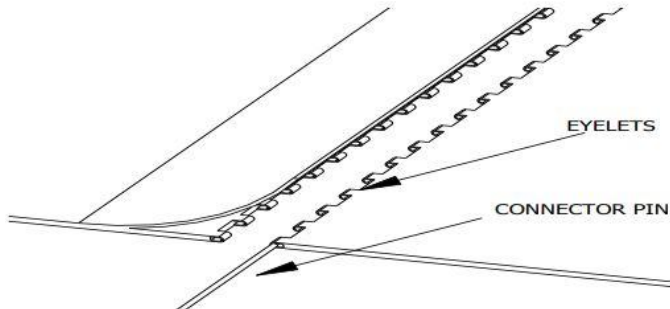

Figure 13: SEAM CONNECTION

Assembly Step 6: Connect Power

Warning: This equipment is operated by high voltage electrical power and can be dangerous. Only a qualified electrician should connect and service this equipment. **Safe and proper installation of this dryer is the customer's responsibility.**

Note: The wiring of the electrical supply to the dryer must be in accordance with all local, state, and national codes.

A main disconnect with overload protection, capable of switching the dryer's full pull load must be installed within reach of the operator.

Each heat section module has an independent power supply that must have an independent overload current protection device not exceeding the MAX OCP rating on the supply information tag on the control panel.

Some modules require two independent power supplies that must **each have an independent overload current protection device** not exceeding the MAX OCP rating on the supply information tag on the control panel.

Each heat section control panel has a disconnect switch located inside the panel. Panels with two power supplies will have two disconnect switches. Wires may enter through the supplied hole at the bottom of the panel, or the customer may elect to punch a hole in the sidewall of the panel. Connect supply power directly to the open terminals of the disconnect switch, and a ground wire to the grounding lug located adjacent to the disconnect switch.

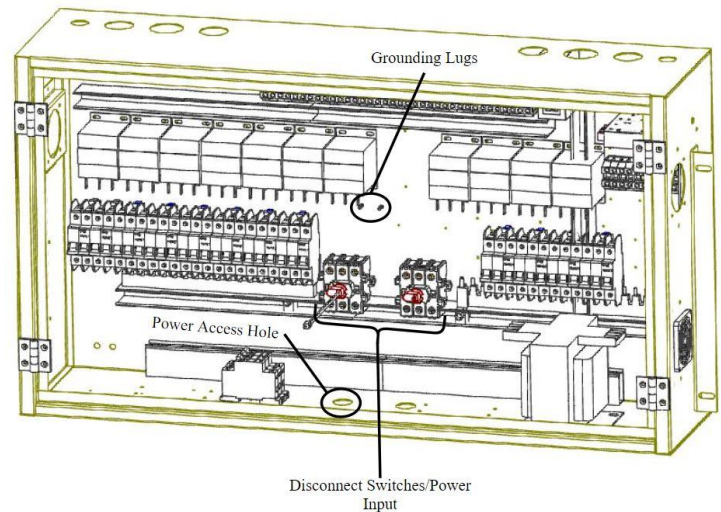

Figure 14: CONTROL PANEL POWER HOOK-UP

Assembly Step 7: Connect Control Kiosk

The control kiosk connects to the logic control panel using three cables – a standard 120V power cable, a VGA cable, and a USB cable. Connect these wires to any compatible ports on the main logic control panel.

Assembly Step 8: Venting

Venting of the dryer exhaust air is recommended. The garments that are cured in this oven will smoke and this will remove most of the smoke from the printing area.

- ◆ Vent the exhaust air flow to the outside of your building with standard 10" diameter duct.
- ◆ Long duct runs and changes in duct direction restricts the air flow. Under certain circumstances an in-line booster fan may be required.
- ◆ The exterior end of the duct should be protected from direct winds that may cause back drafts. Precautions should be taken to prevent rain water from entering the duct work.

Assembly Step 9: Wire Machine

The machine has several internal connections between components that are disconnected for shipping, and must be reconnected to finish installation. Due to the technical nature of these connections, it is recommended only a Brown Technician perform the final wiring operations. Please refer to Appendix A for machine wiring diagrams.

Machine Adjustments

Belt Tension

It is normal for a new belt to stretch within the first year of its life. That is why it is essential to maintain a centered position. Monitor to see if the belt drifts a certain direction and the rate at which it drifts. This will indicate which side of the roller to adjust and the amount it will need to be adjusted.

The side that the belt drifts towards indicates the side that needs to be tensioned. The faster a belt drifts, the more it needs to be tensioned [on the drifting side]. Keep in mind that it is possible to over tension a belt. To check, grab the edge of the belt (near one of the rollers) and try to shift it on the roller. If it cannot be moved, the belt is over tensioned.

Belt Tracking

Belt tracking is adjusted with the red knobs on the end of the conveyor frame. Remember, increasing the belt tension on one side will cause the belt to track towards the opposite side of the dryer frame. Decreasing the belt tension on one side will cause the belt to track towards that side. Additional adjustments may be required when the oven reaches full temperature or as the belt stretches with wear.

Load and Object Detectors Adjustment and Cleaning

The load sensors and object detection (trip) sensors must work correctly for proper operation of the machine. These sensors send an invisible beam of light to a reflective target located under the belt. The beam is reflected by the target and detected by the sensors. A red light above each sensor is activated when the sensor detects the target. If the target is not detected when nothing is blocking the beam, the sensor lenses and target should be cleaned with a rag. Mild solvents may be used to clean off stubborn deposits. Sensors must be pointed at targets, and targets must be located directly in the line of sight of the sensors.

Height Sensor Adjustment and Cleaning

The height sensors on the Firefly operate in emitter-detector pairs shown in Figure 1. One sensor emits a visible red laser beam, while the paired detector senses the beam. If an object blocks the beam, the machine stops the belt and alerts the user to a height sensor error. The height of the beam may be adjusted by moving the sensors up or down in their mounting slots. A yellow light on the detector indicates detection of the emitted beam. The emitter and detector pairs must be aligned such that the beam is always triggering the detector when nothing is blocking the beam. It may be necessary to clean the lenses on the emitter/detector pairs if foreign debris accumulates on the lenses.

Appendix A

Firefly Machine Wiring Diagrams

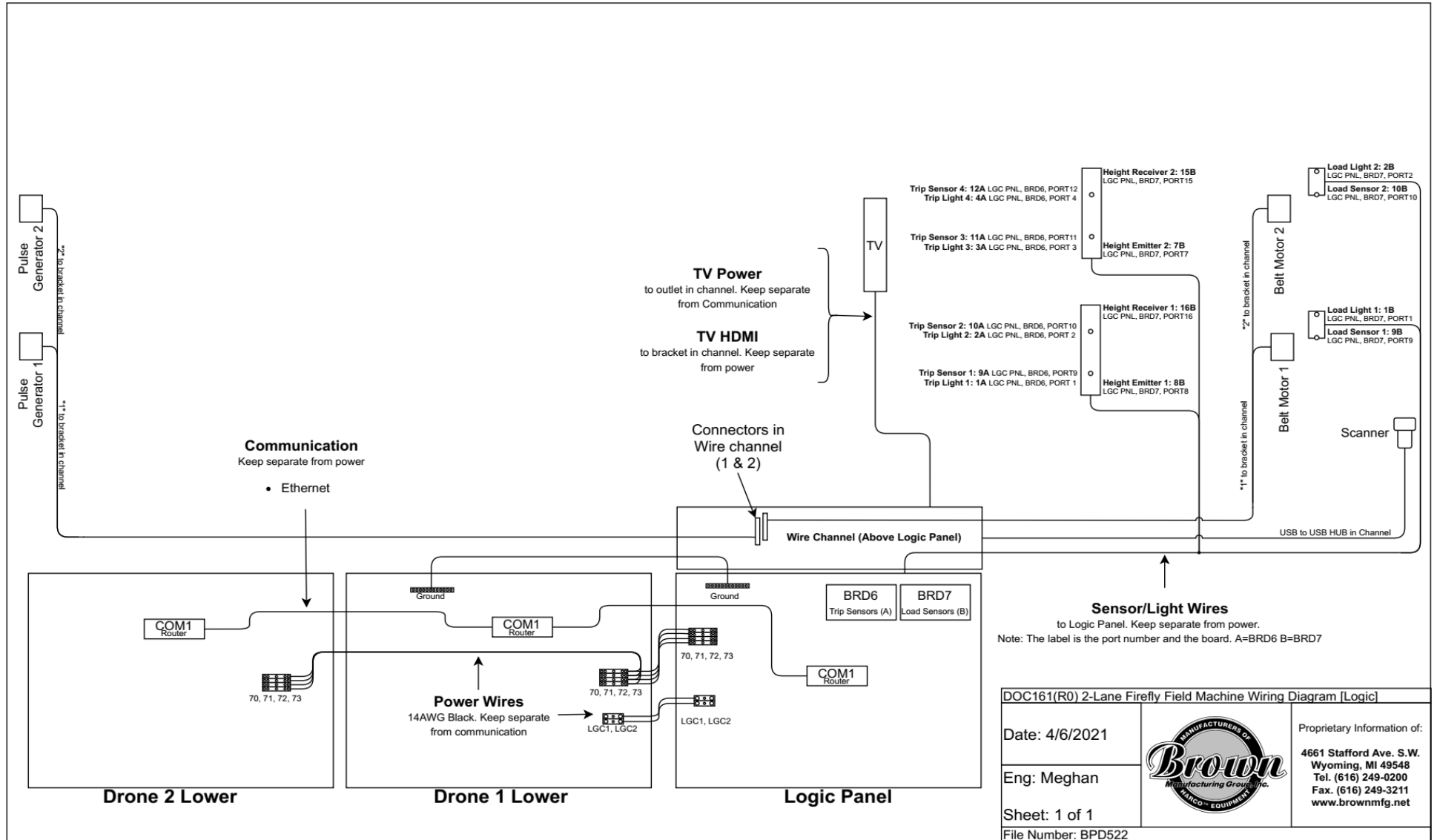
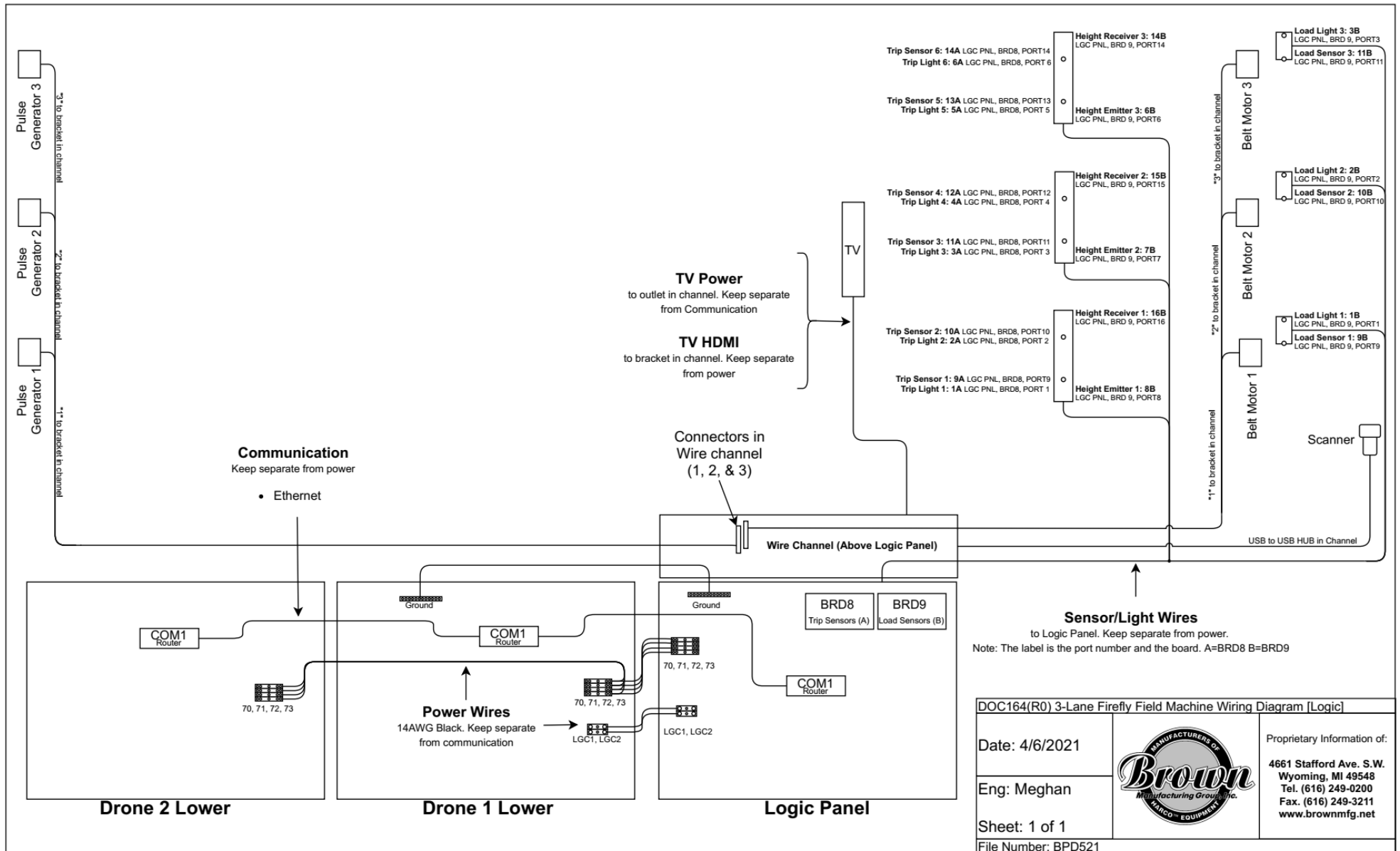

Figure A.2: 2-Lane Firefly Machine Wiring Diagram



DOC164(R0) 3-Lane Firefly Field Machine Wiring Diagram [Logic]	
Date: 4/6/2021	
Eng: Meghan	
Sheet: 1 of 1	Proprietary Information of: 4661 Stafford Ave. S.W. Wyoming, MI 49548 Tel. (616) 249-0200 Fax. (616) 249-3211 www.brownmfg.net
File Number: BPD521	

Figure A.3: 3-Lane Firefly Machine Wiring Diagram



FIRE FLY

Brown Manufacturing Group, Inc.
4661 Stafford Ave. S.W.
Wyoming, MI 49548
Phone: 616-249-0200
Fax: 616-249-3211
www.brownmfg.net
customerservice@brownmfg.net

User's Manual

Revision 6



Table of Contents

Firefly Operation	1
Home Screen	1
Belt Operations	2
Preheat	2
Start/Stop Job	2
Action Icons	3
Programs and Cure Settings	3
Default Program	3
Creating a Program	3
Loading a Saved Program	4
Editing a Program	5
Deleting a Program	5
Maintenance	5
Creating a Maintenance Task	6
Editing a Maintenance Task	6
Deleting a Task	7
Settings Screen	7
Locks	8
Firefly Drone Software	9

Firefly Operation

The Firefly Dryer allows users to customize pretreat-cure and print-cure settings to accommodate the varying styles and types of individual garments.

When the machine turns on, the Firefly software will start automatically and will display the Firefly's Home Screen. This screen will look similar to the one shown below.



Firefly Main Home Screen

A Firefly Dryer can have up to three separate belts. These belts are often referred to as the **Lanes** of the Firefly. Each Lane has its own set of cure parameters, which it uses to cure the garments placed on the belt. Cure parameters are displayed on the Home Screen and are color coded to help users identify a Lane's corresponding settings.

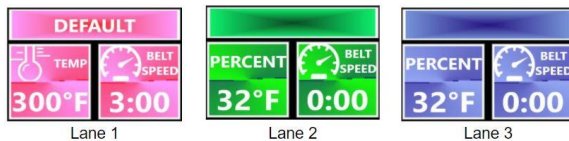

Color-Coded Lane Settings

Upon software start up, all Lanes will be set to use the DEFAULT Program. If desired, the user can select the target temperature and the belt speed for each lane. Alternatively, the user can load a Program, which contains pre saved values for all the cure parameters. More information about creating Programs and descriptions of Program Settings can be found in a later section.

Once the cure settings are selected, the user can either press/scan the barcode above Start/Stop Job to begin sending garments or press/scan the barcode above Preheat to warm the dryer prior to sending the garment. After pressing either of these action barcodes, a message window will appear with an on-screen number pad. This is where the user tells the system which Lane number to perform the action on (preheat or start job). If Preheat is selected, the dryer will initiate a prewarm cycle and the

bulbs will begin heating up to the selected target temperature. If Start/Stop Job is selected, the belt will start moving without initiating a prewarm.

After the belt starts moving, the operator can begin loading garments. The product has to be loaded within the edges of the belt. Anything outside of the belt boundary could catch inside of the dryer leading to a potential fire. For more information about loading technique, see "Proper Loading Technique" located in the **Firefly Technicians Reference**.

⚠ Warning: The belt will be moving. Operators should keep any loose hair, clothing, and accessories away from the belt.

There is a bridge going across the belt located directly in front of the Heat Chamber. This bridge is sometimes referred to as the **Trip Bar** and contains sensors that tell the system when a garment is about to enter the Heat Chamber.

*Note: for more information on how the trip sensors operate, see "Object Detection" in the **Firefly Technicians Reference**.*

If the Start/Stop Job button was pressed instead of the Preheat button, the prewarm will happen when a garment is detected at this Trip Bar/bridge. The belt will stop until the dryer has reached the target temperature. Performing a Preheat before Start/Stop Job can decrease the amount of time that the garment has to wait before entering the Heat Chamber.

*Note: The dryer will need to preheat when left idle for a sufficient amount of time. The prewarm times can be altered in settings. See "Preheat Settings" in the **Firefly Technicians Reference** for more information.*

After the dryer has finished preheating, the belt will start moving and the garment will be sent through the Heat Chamber. The Belt Speed that is displayed on the Home Screen is the amount of time that the garment will be exposed to heat.

The garment will exit on the other side of the dryer where the operator can remove the garment from the belt.

Home Screen

As mentioned before, the cure settings for each Lane are displayed on the Home Screen of the Firefly Main Software. These cure settings are either selected manually or loaded from a desired Program.

The settings displayed for each Lane are as follows:

- **PROGRAM NAME:** The name of the loaded Program that the Firefly is currently using to cure garments
- **TEMP:** The target temperature that the Firefly will reference when curing a garment.
- **BELT SPEED:** The time a garment will spend in the Heat Chamber on the corresponding Lane.

There is an expand icon  located below each Lane that, when pressed, will expand additional cure settings. The screen will look similar to the one shown below when the additional settings are expanded.

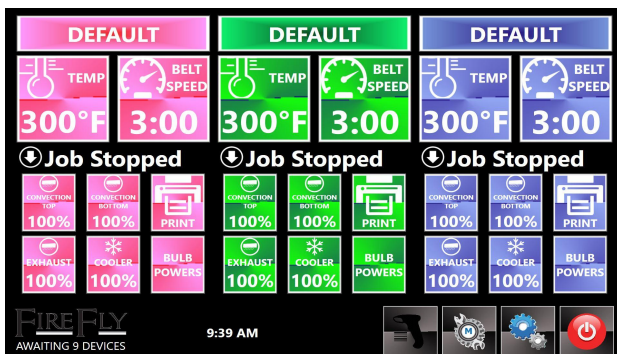

Expanded Program Settings

The parameters available in the expanded view are as follows:

- **CONVECTION TOP*:** This controls the percentage power of the Top Fans, which are located above the Heat Chamber(s).
- **CONVECTION BOTTOM*:** This controls the percentage power of the Bottom Fans, which are located below the Heat Chamber(s).
- **EXHAUST*:** This controls the power (represented in a percentage) of the Exhaust Fan(s), which are located on top of the Drone(s).
- **COOLER*:** This sets the power of the garment Cooling Fan(s).
- **BULB POWERS:** This lists the percentage of power for all the bulbs (in the corresponding Lane's Heat Chamber).
- **PRINT*:** If the unit is equipped with the Linx System, this print button will print the barcode label

for the selected Program.

** Note: Some of these options may not be available. Your Firefly system may not be equipped with Top Fans, Bottom Fans, Cooler, or Linx Connection (Print option). If you are unsure of the features included with your machine, contact your Brown Manufacturing Sales Representative.*

The settings for the fans determine how fast the fan will spin, which is directly related to the amount of air that is moved. The fans are beneficial in specific situations, but it is recommended that they be used in small amounts to prevent lowering the overall temperature of the dryer.

Note: for more information on fan operation and the effects the fans have on the dryer, refer to "Convection Top and Bottom" and "Exhaust and Cooler" sections in Technicians Reference.

Belt Operations

As mentioned previously, the user can tell the system to do one of two things to initiate garment curing: preheat the dryer or start the belt. These actions are controlled by pressing on (or scanning) the corresponding barcode on the Home Screen. The belt status for each Lane will be

displayed next to the expand icon  and will change depending on which action barcode is selected.

Preheat

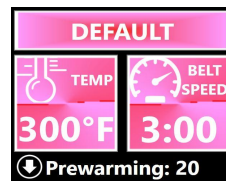

When pressed, the system will initiate a prewarm cycle. The belt status will update to say Prewarming and then show a countdown. The countdown represents the remaining preheat time. When the countdown reaches zero, "Prewarming" will disappear from the belt status (status will be blank) indicating the belt is in normal operation and the operator can begin sending garments.

Start/Stop Job

This barcode only controls belt operation. When pressed while the belt is stopped, it will begin moving and the belt status will be blank indicating that it is in normal operation.

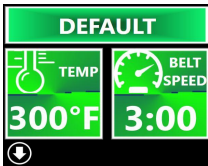

Alternatively, if the belt is running and the button is pressed, the belt will stop and the status will show Job Stopped.

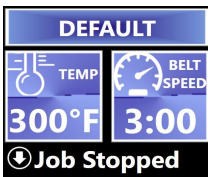

As mentioned earlier, if the operator begins sending shirts while the dryer is cold, the system will automatically perform a prewarm cycle when a garment is detected at the Trip Bar. The belt status will update to show “Prewarming” and then a countdown. When the countdown reaches zero, the status will be cleared and the garment will proceed into the Heat Chamber.

Action Icons

Located in the bottom right corner of the Home Screen are four icons:



POWER DOWN: Pressing this icon will initiate a total system shutdown sequence



SETTINGS: This button will redirect the user to the SETTINGS menu



MAINTENANCE: This button will redirect the user to the Scheduled Maintenance page. It will also flash if a Maintenance Task is overdue. More information about Maintenance can be found in the “Maintenance” section.

Another action icon that the user may interact with is the update icon . This icon will appear towards the bottom left of the screen, in between the time and the Firefly logo. This icon indicates that there is a software update available. It is suggested that the software update is initialized when the machine is not in operation. To update, press on the icon and confirm the update. The software will automatically restart when it has finished installing the update.

Programs and Cure Settings



A Program is a group of settings that were selected prior to machine operation and saved under a user specified name. The cure settings available on the Home Screen, can be selected and saved as a Program. Programs allow for smooth transitions when changing cure parameters.

There are seven different cure settings that the user can use to customize Programs. These were defined at the beginning of the “Home Screen” section of this document. As a reminder, the available Program settings are as follows:

- Temp
- Belt Speed
- Convection Top
- Convection Bottom
- Exhaust
- Cooler
- Bulb Powers

Default Program

When the software first starts, the DEFAULT Program will be displayed for all three Lanes. This Program can be altered as necessary and should be set to the parameters used to cure the majority of the products. To change these settings:

1. Press 
2. Press 
3. Alter the settings as desired. The button in the top right corner will switch to say SAVE when changes have been made.

Note: if you wish to revert the changes, press RESET in the top left corner. To exit the screen without making any changes, press where it says BACK in the top right corner.

4. Press the SAVE button
5. Press HOME to return to the Home Screen

Creating a Program

Creating a Program was designed to be convenient to users. Any time a cure setting is changed on the Home Screen, the header that typically displays the Program

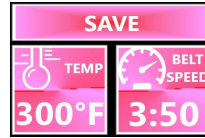

Name will switch to SAVE.



Note: changing a parameter does NOT mean that a Program needs to be saved. The Firefly will use whichever parameters are selected at the start of a job to cure a garment.

All of the cure settings mentioned in the Home Screen section are available to be changed and saved in a Program.



To change bulb power settings:

1. Expand the additional settings under the desired Lane
2. Press on the button that says BULB POWERS
3. Press on the percentage next to the desired bulb
4. Use the number pad to type in a percentage between 0-100% where 0% is off and 100% is full power.
5. Press  to accept the value or  to cancel
6. Change other bulbs as necessary using the same procedure
7. Press  to accept all the bulb power changes



Bulb Power Settings





To change any other cure settings:

1. Press on the desired setting
 - a. Settings include Temp, Belt Speed, Convection Top, Convection Bottom, Exhaust, Cooler
2. Enter the value using the on-screen number pad
3. Press  to accept the change or press  to cancel

After the user has finished altering settings, they can press SAVE and enter an applicable Program Name using the on-screen keyboard.

Reminder: Press  to access additional settings that will be saved as part of the Program.

Keyboard Icons

- : toggles between uppercase and lowercase letters
- : changes the keyboard to display accented letters
- : [Backspace] erases a letter/number from the end
- : cancel without saving and return Home

Loading a Saved Program

There are two different ways an active Program can be changed for a Lane:

1. Using the shortcut on the Home Screen
2. Navigating to the Program Screen in Settings



Both options will bring the user to the Programs page where the user can select from a list of previously saved Programs.



Example Programs Page

Keep in mind that once a Program is loaded, the Dryer will need time to adjust to any changes in temperature, belt speed, and airflow. For example, a Program is loaded with a higher temperature than the one it just replaced. The system will have to initiate a prewarm to reach that temperature during which garments will not be sent.

Option 1: Program Selection Shortcut





1. Press on the Program Name currently displayed for the desired Lane
2. Select the new Program Name from the list
 - a. Use  and  to navigate to different pages of saved Programs.

After a Program has been selected, the user will be redirected back to the Home Screen where the selected

Program will be displayed in the Lane settings. To return to the Home Screen without selecting a Program, press HOME in the top left corner of the PROGRAMS Screen.

Option 2: Program Selection from Settings

This option involves a few extra steps, but the user can select a Program for all the Lanes while in this screen.

1. Press 
2. Press 
3. Select the desired Program Name from the list
4. Using the on-screen number pad, enter the desired Lane number to apply the selected Program
5. Press  to load the Program or press  to cancel
6. As necessary, repeat steps 3-5 for the other Lanes
7. Press HOME in the top left corner

Editing a Program

There are three ways the user can edit an existing Program.

Option 1: Home Screen

Edit the settings directly on the Home Screen. Useful when trying to edit settings that have already been loaded into the Home Screen.

1. Change the cure settings on the Home Screen to the desired values.
2. Press SAVE and type in the same name as the Program you are trying to edit.

Option 2: Program Selection Shortcut

Edit the settings using the Program selection shortcut. Useful when loading a different Program and want to check/change a value before loading it.





1. Press on the Program Name of the currently displayed settings.
2. Locate the desired Program from the list
3. Press and drag the Program name to 
4. The settings will be displayed in the same editing format as the DEFAULT program
5. Press SAVE after editing the desired values.

After pressing SAVE, the program will automatically be loaded into the Lane settings and the user will be redirected to the Home Screen.



To cancel the Program changes, press RESET to return any edited values to what they were originally and then press BACK. To return to Program selection without changing values, press BACK.

Option 3: Settings

Edit the Programs from Settings. This is useful when trying to edit Programs for multiple Lanes or if the user wants to edit a Program for future use (does not want to load it into the Home Screen).

1. Press 
2. Press **PROGRAMS**
3. Press and drag the desired Program Name to 
4. Edit the values as necessary
5. Press SAVE. The user will be redirected to the Programs page.
 - a. Can press RESET then BACK to return to the Programs page without making changes
6. Press the newly edited Program Name to apply it to a Lane
7. Enter the desired Lane number then press  to load the Program or press  to cancel
8. As necessary, repeat steps 3-5 for the other Lanes
9. Press HOME in the top left corner



Deleting a Program

1. Navigate to the Programs screen by pressing:
 - a. on a loaded Program Name or
 - b.  → **PROGRAMS**
2. Locate the desired Program
3. Press and drag the Program to 
4. A message will appear asking the user to confirm the deletion of the selected Program. Verify the correct Program is selected
5. Press YES to delete or NO to return to the Programs page without deleting

Note: If a currently loaded Program is deleted, the Program Name and its settings will remain on the Home Screen until the Program (or its settings) is(are) changed.

Maintenance



Normal wear and tear on the Firefly is inevitable over time. The maintenance activities outlined in the Firefly Maintenance Manual are designed to prolong the life of essential components and keep the Firefly functioning at optimal efficiency. Since there are multiple maintenance activities that need to be performed and each at varying times, the Maintenance feature was designed to help keep track of upcoming tasks. To schedule or view maintenance events, press  located on the bottom right of the Home Screen. The Maintenance page can also be accessed by pressing  then on **MAINTENANCE**. The Maintenance page will look similar to the one shown below.

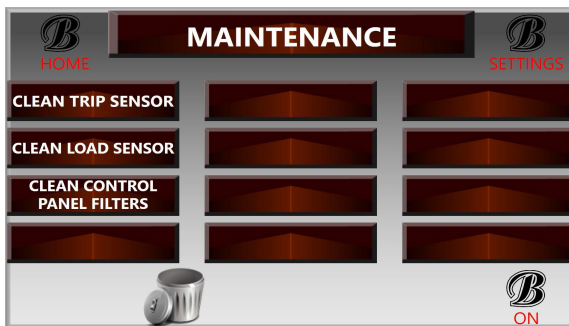



Example Maintenance Page

To return to the Home Screen, press HOME in the top left corner of the screen.

The Maintenance icon will flash on the Home Screen to indicate that a task needs to be performed. When the user presses on the flashing icon, the task that is due will be the one flashing red on the Maintenance task list. The user can perform this task then press COMPLETED TASK TODAY to reset the task countdown.

If the user does not want to implement this feature or would like to disable task notifications:

1. Press  on the Home Screen
2. In the bottom right corner press 
 - a. This will switch the text to OFF indicating that the notifications are disabled
 - b. Can also disable all maintenance task notifications from any of the Task

Scheduling Screens.

3. Press HOME to return to the Home Screen

Notice that  will no longer be displayed on the Home Screen when the notifications are disabled. Even though the icon is not displayed, the user will still be able to press in the empty icon box to navigate to the Maintenance page. The tasks that are due will still flash red on this page even though the Home Screen notifications are disabled. Re-enable the notifications by following the same procedure except press OFF to turn it to ON.

Creating a Maintenance Task

To create a task, press on one of the empty red Maintenance Slots. The screen will be redirected to look similar to the one shown below.

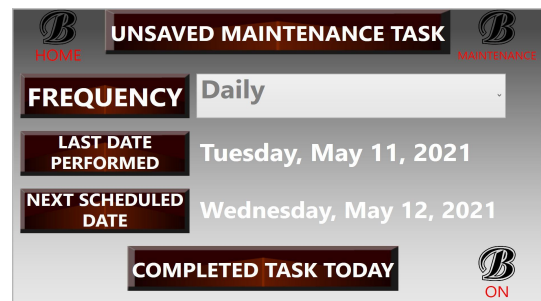

Task Scheduling Screen

The frequency is how often the event will occur. To change this, press on the box next to Frequency. A drop down menu will appear with the following options:



- Daily
- Weekly
- Monthly
- Quarterly
- Semiannually
- Yearly

*Note: Recommended maintenance tasks and frequencies can be found in the **Firefly Maintenance Manual**.*

Select the date that the task was last performed by pressing on the currently displayed date next to LAST DATE PERFORMED and selecting the correct day from the calendar. If it has not been performed yet, select a future date that the task should be performed by.



The NEXT SCHEDULED DATE will update automatically based on the first two responses.

Press COMPLETED TASK TODAY if the task was performed that day and the LAST DATE and NEXT SCHEDULED will automatically update.

Save the task by pressing the title bar at the top that currently says UNSAVED MAINTENANCE TASK. Enter the Maintenance task to be performed using the on-screen keyboard. Press  to save the task or press  to cancel. Press the MAINTENANCE button in the top right to return to the Maintenance page. The new task will appear in the selected Maintenance Task Slot.

Editing a Maintenance Task

To edit a Maintenance task, first navigate to the



Maintenance page by either pressing  on the Home Screen or by pressing  then on . Select the desired task from the task list. After pressing a task, the screen will redirect the user to the Task Scheduling Screen. The user can then edit the desired details of the selected task, including the name of the task.

If the user would like to replace an existing task with a new one, they can follow the same procedure above. When in the Task Scheduling Screen, they can enter the details for the new task and then rename it by pressing on the title bar.

When finished, press the HOME button to return to the Home Screen or the MAINTENANCE button to return to the Maintenance page.

Deleting a Task

Deleting a task is similar to the procedure used to delete a Program.

1. Navigate to the Maintenance page by pressing  on the Home Screen
2. Locate the desired task to be deleted
3. Press and drag the task to 
4. A message will appear asking the user to confirm the deletion of the task. Press YES to delete the task or press NO to return to the Maintenance page without deleting.

Settings Screen



The Settings Screen can be accessed by pressing  located in the bottom right corner of the Home Screen. When pressed, the user will be redirected to a screen that looks similar to the one shown below.

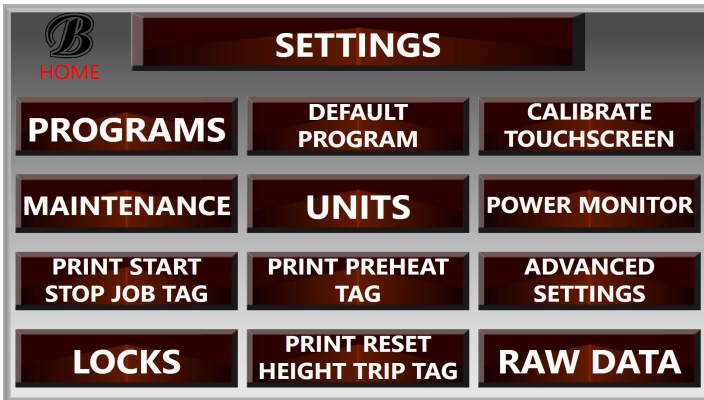

Example of the Settings Screen

The available options on this menu include:

- **PROGRAMS:** Brings the user to the Programs page as explained in the Programs and Cure Settings section
- **DEFAULT PROGRAM:** Brings the user to the Default Program settings as explained in the Programs and Cure Settings section
- **CALIBRATE TOUCHSCREEN:** Redirects the user to the calibration executable that was provided by the touchscreen's manufacturer.
- **MAINTENANCE:** Brings the user to the Maintenance page as described in the Maintenance section
- **UNITS:** Allows the user to select their preferred units
 - **TEMPERATURE:** Toggles between Fahrenheit and Celsius
 - **CURRENCY FORMAT:** Select the preferred currency from the list of available options
 - **ELECTRICITY COST:** Enter your current electricity cost in kilowatt per hour
 - **HOURS PER DAY:** Enter your standard workday length
 - **DAYS PER WEEK:** Enter your standard work week length
- **POWER MONITOR:** The Firefly

monitors the power usage of the monitor. Press this to view a report of power consumption. The user can also press EXPORT in the bottom left corner to generate a report of this information

- **PRINT START STOP JOB TAG:** This sends a copy of the Start/Stop Job barcode to the barcode printer. This is the same barcode that operators can scan on the Home Screen to Start/Stop Job.
 - Can be placed next to Lanes to be more accessible. Also a physical barcode may be easier to scan than one on a monitor.
- **PRINT PREHEAT TAG:** Sends a copy of the Preheat barcode to the barcode printer. This is the same barcode that operators can scan on the Home Screen to Preheat a Lane.
- **ADVANCED SETTINGS:** Brings up the Advanced Settings menu. Contains diagnostic tools and system settings. Users should not change these values unless directed to do so by Brown Manufacturing Technicians
- **LOCKS:** Allows the user to set a password and select from a list of screens/features that are available to be locked. More information in a later section.
- **PRINT RESET HEIGHT TRIP TAG:** Prints a copy of the barcode used to tell the system that a blockage has been cleared (see image below). The height sensor(s) alert the user of bulky garments that are too close to the bulbs and could be a fire hazard. For more information on the Height Sensor(s) refer to "Firefly Height Adjustment" section in the **Firefly Technicians Reference**.

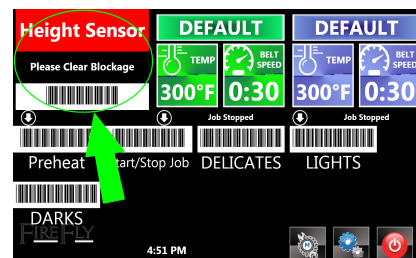

Firefly Height Sensor Blockage

- **RAW DATA:** A detailed record of the activity in each Zone (on each Lane). Displays the Program, Target Temp, Target Time, garment detected, Motor Position, Belt Position. Helpful for problem troubleshooting.

Locks

The Locks page is where the user can set a password and lock certain screens and features.

To set a password:

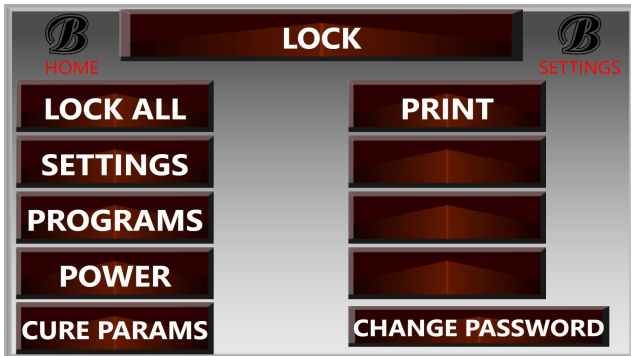

1. Press 
2. Press LOCKS
 - a. The Locks page will look similar to the one shown below



Locks Screen

3. Press **CHANGE PASSWORD**
4. Use the on-screen keyboard to enter a desired password



The features/screens available to be locked include:

- **SETTINGS:** User will have to enter the password before accessing the Settings menu 
- **PROGRAMS:** Users will have to provide a password when trying to access the Programs page. This includes:
 - accessing the page from SETTINGS
 - accessing the page to switch programs using the shortcut on the Home Screen (pressing on the Program Name at the top of any Lane settings)
- **POWER:** User will have to provide a password after pressing the power down icon 

- **CURE PARAMS:** Users will not be able to manually change any cure parameters on the Home Page (not even with a password). The only way to change a Lane's parameters would be to change the Program or to unlock the CURE PARAMS in LOCKS.

The user can press on any of the options listed on this screen to lock it. To lock all the options listed, press the LOCK ALL button. A lock icon  will appear next to an option when it is locked. Similarly, press on any option with the lock icon to unlock it. There will not be an icon displayed when an option is unlocked.

To remove a password:

1. Press 
2. Press LOCKS
3. Press **CHANGE PASSWORD**
4. Press  without typing anything
5. Press HOME to return to the Home Screen or SETTINGS to return to the Settings Screen
 - a. Upon exit, a message will appear saying that a password has not been set and will ask the user if they would like to continue. Press YES to continue or press NO to return to the LOCKS screen.

To exit the LOCKS page, press the HOME button in the top left corner to return to the Home Screen or press SETTINGS to return to the Settings Screen.

Firefly Drone Software

There is a touchscreen mounted to the Upper Control Panel door on each Drone. The Firefly Drone Software is displayed on these touchscreens and will look similar to the one shown below.

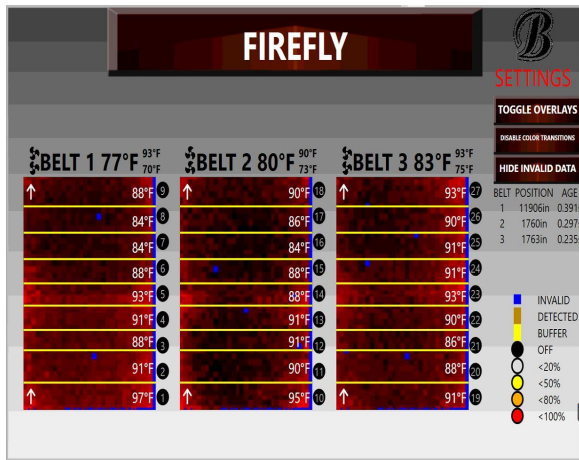

Example of the Drone Software Home Screen

In the Drone Screen example, there are three large, red rectangles. These rectangles represent the three Lanes of the Firefly and can be distinguished by the header above each rectangle (Belt 1, Belt 2, Belt 3). The user will see one to three rectangles depending on how many Lanes are on their machine. Each rectangle consists of two squares. These show the images that the IR Cameras are seeing. The IR Cameras detect and measure the thermal energy of objects and convert the thermal data into an electronic image; meaning, from these images, the user will be able to monitor temperatures while also tracking the movement of the garment.

The Drone has two cameras designated to each Lane. Camera 1 for each Lane is the camera on the side closest to the Kiosk (see image below).

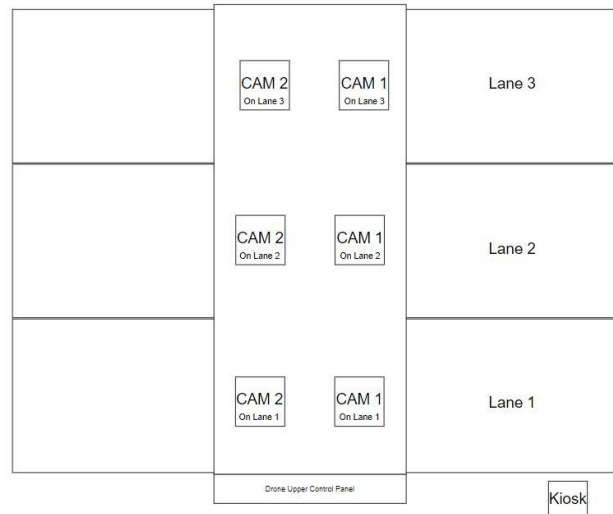

Camera Physical Layout

In the software, Camera 1 is the bottom image in each Lane rectangle.

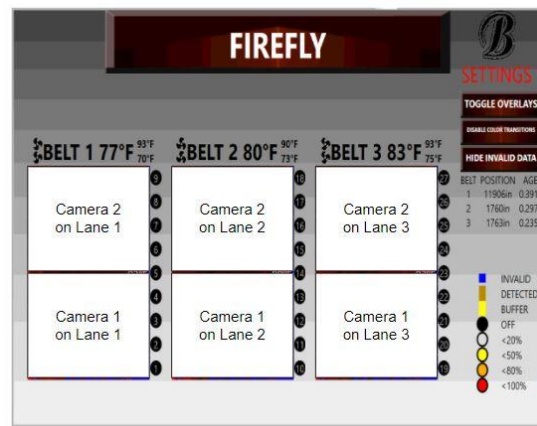

On-Screen Camera Layout

Note: the cameras may also be referred to as Camera 1-6 instead of saying "Camera <1 or 2> on Lane <#>".

In addition to the camera images, the following information is displayed for each Lane:

- **Belt Direction:** indicated by the arrows in the top/bottom left corner of each rectangle.
- **Bulb Powers:** there are nine circles to the right of each rectangle. These represent the nine bulbs used to cure garments. The color of the circle indicates the percentage power of the bulb. A Key showing the meaning of each color can be found on the bottom right side of the screen.
- **Bulb Temperatures:** the temperature for each bulb can be found to the left of the corresponding bulb circle.

- **Top/Bottom Fan Power:** the two fan icons to the left of the displayed Belt <#> respectively represent the power of the Top/Bottom Fans. If the fan is running, the corresponding icon will spin (on the screen). If the icon is not moving, then the fan is off.
- **Average Temperature:** will display the average temperature of the heat chamber (for that Lane). Located to the right of the displayed Belt <#>
- **Maximum Temperature:** is the top value located next to the Average temperature. Displays the highest temperature value that is currently being received.
- **Minimum Temperature:** the top value located next to the Average temperature. Displays the lowest temperature that is currently being received.
- **Object Detection:** During operation, a yellow bar will appear to the left of each rectangle. Since it may be hard to watch a curing garment using the camera images, this bar will show the garment's location as it travels. The detected garment will appear as a dark orange band in the yellow bar. The meaning of the colors will be displayed in the Key located in the bottom right side of the screen.

There are two colors that the user may see in the displayed camera images: red and blue. The red indicates normal operation and there are varying shades of red that will be displayed. Brighter shades of red indicate higher temperatures. Darker shades of red represent cooler bulb temperatures.

Any blue areas in the camera images represent invalid data. It is normal for a camera to show a few blue spots in an otherwise red image. The user can hide these blue sections by pressing on the button that says **HIDE INVALID DATA** (underneath the **SETTINGS** button). If a camera square is completely blue, that means the camera is disconnected. The system will attempt to reconnect the camera by turning both cameras on that Lane on/off.

Additional features that the user may see on the Drone Home Screen include the following:

- **SETTINGS:** Typically used for diagnostic purposes and contains the following features
 - **THERMAL INFO**
 - **SOFTWARE VERSIONS:** shows the current version of the software
 - **CALIBRATE TOUCHSCREEN:** will run the calibration software that was provided by the touchscreen's manufacturer.
 - **POWER MONITOR:** Displays a record of the monitor's power usage
 - **MODBUS DIAGNOSTICS:** Used for diagnostic purposes
 - **NETWORK SETTINGS:** Shows the devices connected to the network and their associated Device IDs
 - **RAW DATA:** Displays the Program/Target Temp/Target Time/Object Detection/Time/Motor Position/Distance/Bulb for various positions in the specified Zone.
 - **SHOW DESKTOP:** will bring the user to Windows Desktop when pressed (without closing the Drone Software)
 - **REMOTE ACCESS:** Initiates TeamViewer Remote Access. Brown Technicians use this to help users troubleshoot issues.
 - **FACTORY SETUP**
- **TOGGLE OVERLAYS:** "overlays" can be set up to hide any unwanted data from the IR images. Overlays should only be added if there is a valid reason (i.e. Brown Technician adds it to cover a harsh red line)
- **DISABLE COLOR TRANSITIONS:** will disable the color transition feature on the camera images. Notice that the camera image is made up of a bunch of little red squares. The color transition takes these and blends them to make the image less blocky.

- **UPDATE:** will appear on the screen when there is a software update available. It is suggested that the software update be initiated when the machine is not in operation. Click on the UPDATE text to initialize the update.
- **Belt Positions:** shows the current belt positions for each Lane. If this value is not changing, it could indicate that the Drone is not receiving commands from the Firefly Main software.
- **ERROR:** will appear in the bottom right corner of the screen (under the Key) when the Drone is experiencing an error. Click on the ERROR text to view the errors.



Brown Manufacturing Group, Inc.
4661 Stafford Ave. S.W.
Wyoming, MI 49548
Phone: 616-249-0200
Fax: 616-249-3211
www.brownmfg.net
customerservice@brownmfg.net

FIRE FLY

Conveyor Dryer Maintenance Guide Revision 6

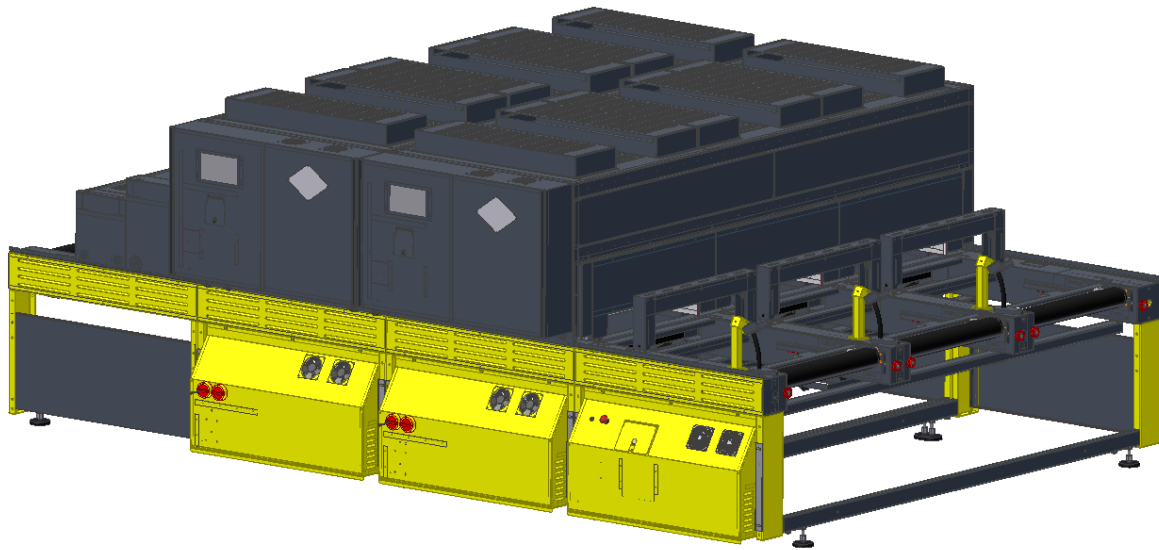

Recommended Weekly Maintenance:

- Clean and Adjust Trip Sensor System
- Clean and Adjust Load Sensor System
- Clean Control Panel Fan Filters
- Check Belt Tracking
- Check Bulb Status

Recommended Monthly Maintenance:

- Check Camera Cooling Fan Filters
- Clean Blinders
- Clean Camera Lenses
- Check Bulb Blinders Alignment
- Check Camera Alignment
- Clean Belt Movement Sensor

Clean and Adjust Trip Sensor System:

The trip sensor bridges are located at the front of the heat chamber (Figure 1). The sensor indicator lights on top of the bridges should be on when no object is present on the belt. A strip of reflective tape is located under the belt directly underneath the trip sensor bridges, and should be kept clean to properly reflect the light emitted by the sensors. The bridges should be positioned properly such that the sensors are located directly over the reflective target.

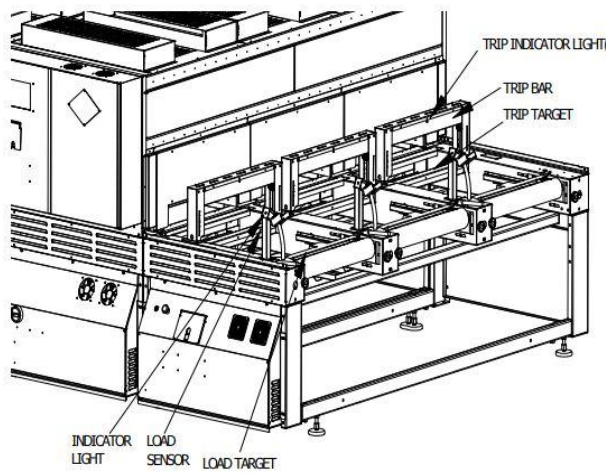

Figure 1: Trip Sensor System

Clean and Adjust Load Sensor System:

The load sensors are located at the front of the belt (Figure 1). The sensor indicator lights on top of the sensors should be on when no object is present on the belt. A strip of reflective tape is located under the belt, and should be kept clean to properly reflect the light emitted by the sensors. The sensors should be positioned properly such that the sensors are pointed directly at the reflective target.

Clean Control Panel Filters:

Each Drone Upper Control Panel has three filters located on top of the panel and three located below (Figure 2). Lift up the cover that is connected to the top of the control panel to access the top filters. Remove the filters by unscrewing the acorn nuts located in the corners of all the filters. Reattach filters and close the top filter cover when finished.

There are also two filters located on the sides of the Lower Control Panels (Figure 2). These foam filters can be accessed by popping off the black, plastic cover (Figure 3).

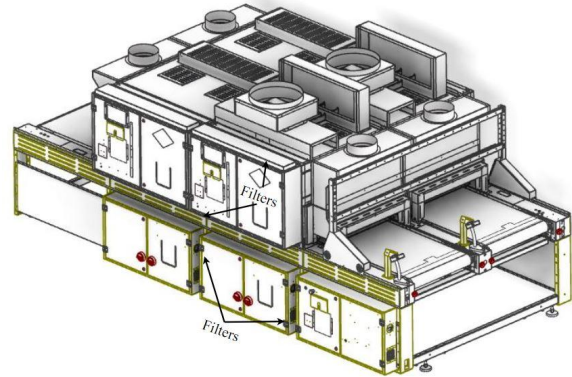

Figure 2: Control Panel Filters

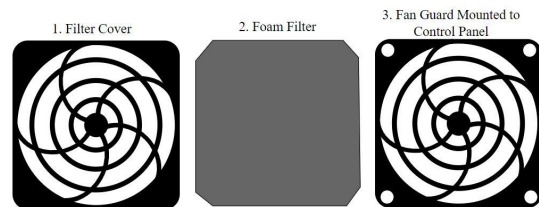

Figure 3: Lower Control Panel Filter

Check Belt Tracking:

Each belt should lay in the center of the drive and take-up rollers. If the belt tends to drift to one side or the other of the roller, the roller should be adjusted. A red knob on either side of the roller allows the roller to be twisted (Figure 4). The belt will tend to drift towards the side which is loosest. Thus, pull the roller out on the side toward which the belt is drifting, or push the roller in on the opposite side. The belt should never be pulled so tight that the belt cannot be shifted on the roller by pulling it firmly with one's hands.

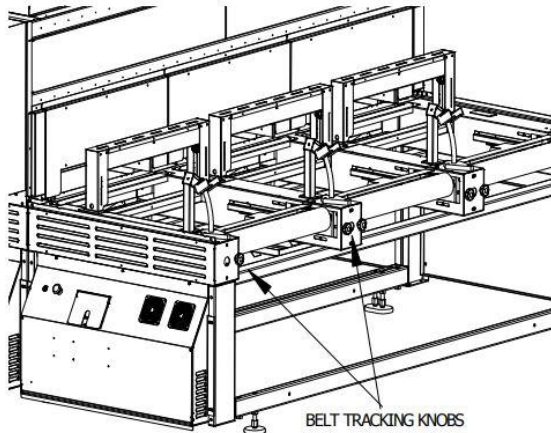

Figure 4: Belt Tracking

Check Bulb Status:

- 1) At each drone control panel press “Menu”
- 2) Press “Factory Setup”
- 3) Press “Test Bulbs”
- 4) Bulb test will report “Successful” if all bulbs are working correctly, or will identify those bulbs that are not working.

Replacing a Bulb:

Before replacing a bulb, it is important to determine that the bulb is, in fact, the problem.

- 1) With nothing on the belt, make sure the lane with the suspect bulb has been started (use the “start/stop job” option on the main kiosk).
- 2) On the Drone control panel, select “Menu”.
- 3) Select “Factory Setup”
- 4) Select “Bulb Setup”
- 5) Choose belt (zone) in question (Figure 5)
- 6) Circles at the right of the image represent bulbs in the zone. (Front bulb is the bottom circle.)
- 7) Press circle corresponding to suspect bulb. If the circle turns green, the bulb is being commanded to turn on.
- 8) Visibly inspect the bulb to see if it is on or on or not.

If the bulb is truly not coming on, it should be replaced.

- 1) Turn off the machine.
- 2) Turn off all disconnect switches (red knobs on drone panels)
- 3) Pull sections apart if necessary to access the bulb rack with a bad bulb (Figure 6). Note wire conduit strain while moving sections.
- 4) Pull bulb rack out.
- 5) Remove guards to access bulb wire connections.
- 6) Disconnect wires to bulb.
- 7) Pull wires out of bulb rack metal.
- 8) Remove bulb from rack by sliding bulb left and right. (It will probably be necessary to use fingers to slightly expand bulb holders to allow bulbs to slide).
- 9) Reverse steps to install a new bulb. Wear gloves when handling a new bulb. Hand oils can cause bulbs to overheat.

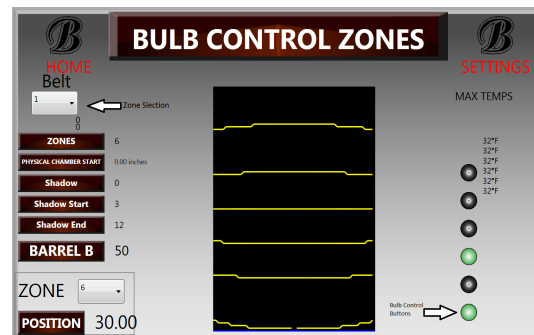

Figure 5: Bulb Control Screen

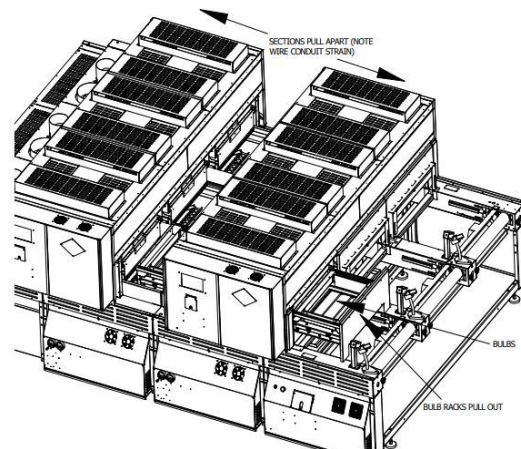

Figure 6: Bulb Access

Check Camera Cooling Fan Filters:
Inspect camera cooling fan filters above main heat sections (Figure 7). Replace as necessary.

Clean Blinders:

- 1) Remove camera access plate (Figure 7)
- 2) Clean lint & dust from camera cooling fans and camera bulb blinders.

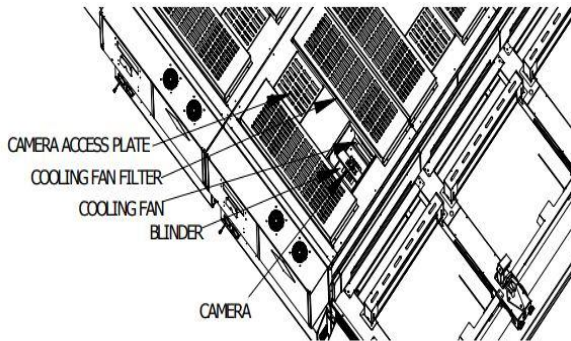

Figure 7: Camera Access

Clean Camera Lenses:

- 1) Remove camera access plate (Figure 7)
- 2) Use a lint-free cloth to gently clean any lint or dust from bottom lens of camera

Check Bulb Blinders Alignment:

- 9) With nothing on the belt, make sure each lane has been started (use “start/stop job” option on main kiosk.
- 10) On each drone control panel select “Menu”.
- 11) Select “Factory Setup”
- 12) Select “Bulb Setup”
- 13) Press each circle at the right of the image once to turn each circle green. This will turn the bulbs on in the selected lane. (Figure 5)
- 14) Wait 2 minutes. All temperatures should be similar in value, all should be less than 290 degrees.
- 15) Press each green circle again to turn them all off.
- 16) Select the next zone from the drop-down “Belt” list at the top-left.
- 17) Repeat steps 5-8 until all zones have been tested.

If any of the lanes show high temperatures (above 290 degrees), push the bulb rack as far as it can go in its track.

If temperatures continue to be high, contact Brown Manufacturing for instructions on adjusting the camera bulb blinders.

Check Camera Alignment:

During normal operation of the machine, a series of dark lines will show up on each camera image. These lines will be slightly curved, but should overall run straight left-right across the image. If a camera is twisted in its socket, the lines will tend to run “downhill” from one side of the screen to the other. To fix this issue:

- 1) Remove camera access plate (Figure 7)
- 2) Loosen camera holder screws a very small amount (1/2 turn each screw)
- 3) Gently twist the camera in its socket until the picture on the screen is correct.
- 4) Tighten camera holder screws FINGER TIGHT ONLY. Make sure the screws press only on the edge of the main circuit board on the camera.
- 5) Make sure that as objects travel through the lane, they first appear at the bottom of the image, and travel towards the top. This ensures the camera has not been rotated 180°.

Clean Belt Movement Sensor:

The belt movement detection system is located on the left-hand side of the take-up roller (Figure 8). Remove the side cover guard to access the mechanism.

Clean any dust/lint that may have built up on the disk/sensor system.

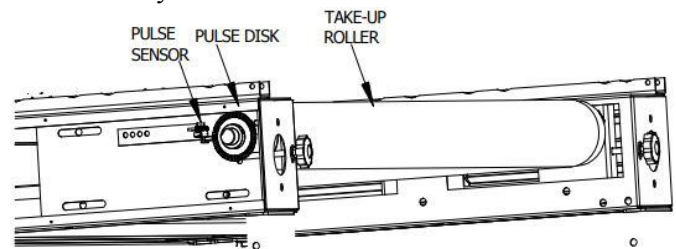

Figure 8: Belt Movement Sensor System



Brown Manufacturing Group, Inc.
4661 Stafford Ave. S.W.
Wyoming, MI 49548
Phone: 616-249-0200
Fax: 616-249-3211
www.brownmfg.net
customerservice@brownmfg.net

FIRE FLY

Conveyor Dryer

Technicians Reference

Revision 6

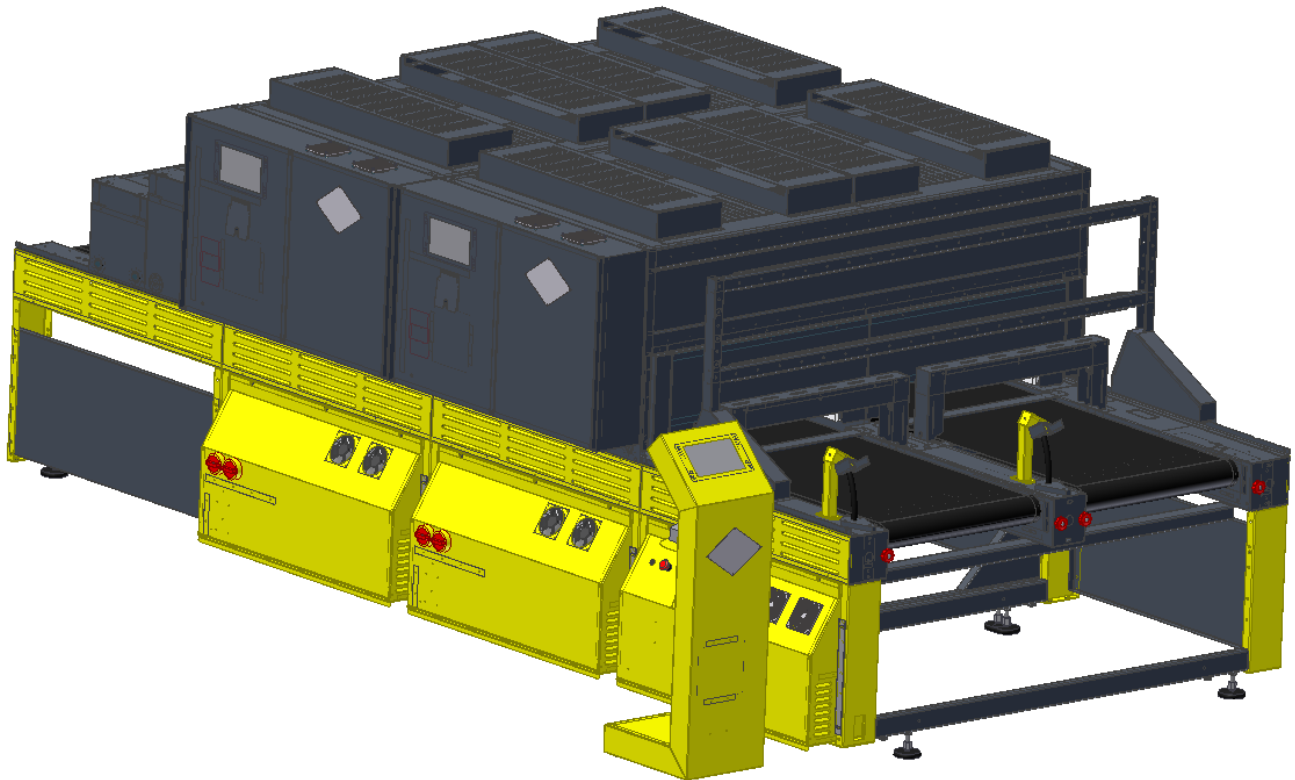

Purpose:

This document is intended for those who are already familiar with Firefly operation and are looking for additional information on optimizing curing parameters, subsystem functionality, and problem troubleshooting. For more information on Firefly operation, please refer to **Firefly Software**. Keep in mind that a lot of the problems that are mentioned in this document can be easily avoided by following the maintenance activities described in the **Firefly Maintenance Manual**.

It is suggested that at least one person per operating shift becomes familiar with the information outlined in this document. This will reduce production down time and teach users how to use this system to its full potential. Due to the amount of information covered in this document, it is also recommended that this guide be kept in an easily accessible location (near the Firefly Curing System) to act as a quick reference during machine operation.

Table of Contents:

Purpose of this document:	2
Table of Contents:	2
Program Settings:	3
Temp:	4
Belt Speed:	4
Convection Top & Bottom:	4
Exhaust and Cooler:	5
Bulb Powers:	5
Default Program:	5
Bulb Control Modes:	6
singleBulb:	7
tripleBulb:	7
twoBulb:	7
leadingBulb:	7
Prewarm Settings:	7
Object Detection:	8
Load Detect:	10
Proper Loading Technique:	11
Snags	11
<i>Wrinkles</i>	12
Folds	12
Height Sensor Adjustment:	12
Editing Program Barcode IDs	13
Troubleshooting Common Problems:	14

Program Settings:

Cure parameters (also called “Programs”), are usually set at the main screen on the control Kiosk (Figure 1). These parameters can be saved with user-defined names, and can be recalled by pressing a button on the kiosk, or scanning a barcode (on devices with the optional scanner software).

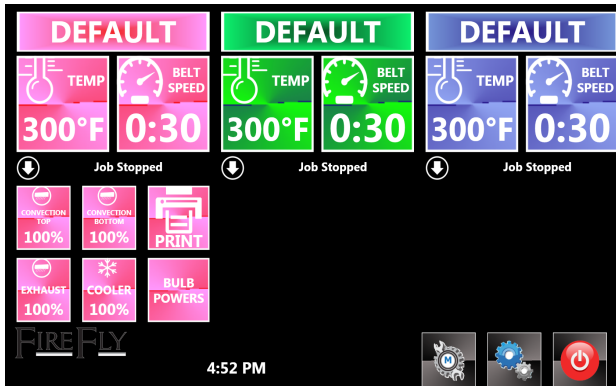

Figure 1: Main Control Screen

Cure parameters are applied to products laid on the belt when the parameters are active on the main screen. It is possible to change the parameters several times while laying several different products on the belt, and have the correct cure parameters follow the product down the belt and through the heat chamber. Consult the “Load Detect” section of this manual for more information on changing parameters between products.

Temp:

This is the cure temperature of the product. The Firefly Curing System will attempt to bring the product up to this temperature as quickly as possible, and maintain this temperature as the product moves through the dryer.

Belt Speed:

This is the amount of time (in minutes and seconds) the product will receive heat from the heating elements. This does not include time spent outside the heat chamber or under the exhaust section.

The Firefly Curing System uses an intelligent algorithm to control the belt speed. When products are not being cured, the belt runs at a default (usually fast) speed. Once a product is detected, the belt will adjust its speed based on the Program settings for that product. The “Belt Speed” that was defined in the product’s Program settings, is the exact amount of time that it spends in the heat chamber.

If a second product, requiring less cure time, were to enter the heat chamber at the same time, the bulbs above that second product would turn off once it reached its set amount of time. This means that multiple different products with varying cure times could run down the same belt without interfering with one another.

Convection Top & Bottom:

Each Firefly Module (“Drone”) has independent Top and Bottom Recirculation Air (also called “Convection Air”). The convection air setting is saved with each program, and thus changes as products traveling through the conveyor calls for more or less air.

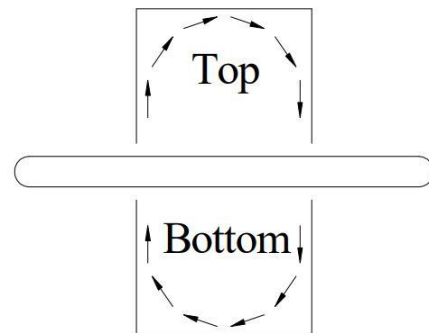

Figure 2: Convection Air

Top air is advantageous when drying certain water based inks, such as, digital and solvent-based prints. However, it has a negative effect on the performance of certain plastisol inks, especially when attempting to control dye migration on polyester products.

Bottom air is beneficial when attempting to dry solvents that have soaked through to the bottom side of the product. This includes certain digital prints or freshly dyed material.

For optimal efficiency and performance, the convection air should be used in small amounts. Convection air tends to decrease the energy transferred to the product from the bulbs (via radiation).

Exhaust and Cooler:

The exhaust and cooler settings are also contained in each program, such that certain products may have these fans turned on while other products may have them turned off. Use of the exhaust and cooler fans is optional.

Bulb Powers:

The Firefly Curing System has the ability to set independent bulb powers for every bulb in the system. These powers are set using the expanded program options on the main screen (Figure 3)

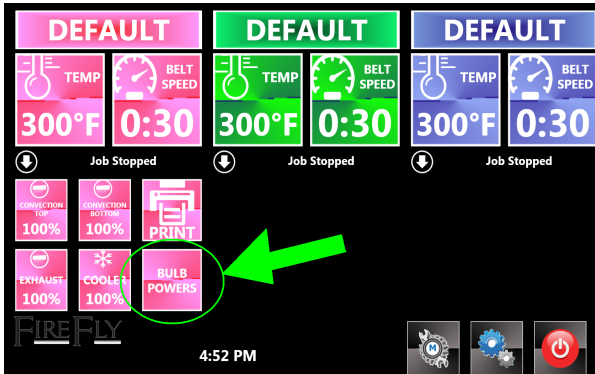

Figure 3: Bulb Powers Option

Controlling the bulb powers allows flexibility in managing the intensity of heat in the system. Setting all bulb powers at 100% ensures maximum intensity heat, which is ideal for production performance. Lower power settings allows for moderate intensity heat for delicate applications. Varying powers can be set to optimize specific jobs, such as setting high bulb powers on the front few bulbs to act as an initial “bump”, and setting the rest of the bulbs lower to

maintain the cure temperature while minimizing any possible overshoot.

Generally slower belt speeds require lower bulb powers, whereas faster belt speeds require higher bulb powers.

Default Program:

When the Firefly Curing System first powers on, every belt loads the “Default” program cure parameters. These parameters may be adjusted at the main control Kiosk by choosing “Settings” → “Default Program” (Figure 4)

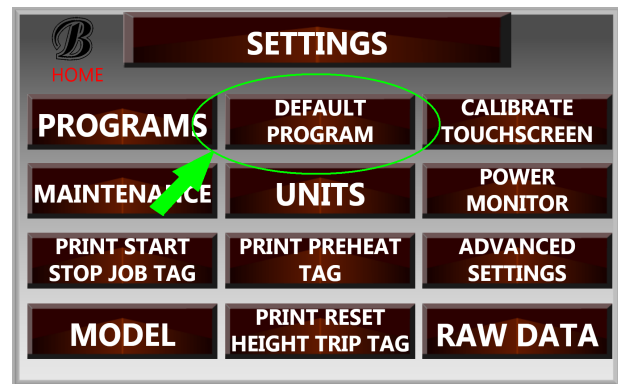

Figure 4: Default Program Button

In the Default Program Screen (Figure 5), the default cure parameters may be adjusted. If adjustments are made, the “Back” button will change to “Save”. Press the “Save” button to save changes, or “Reset” to discard changes.

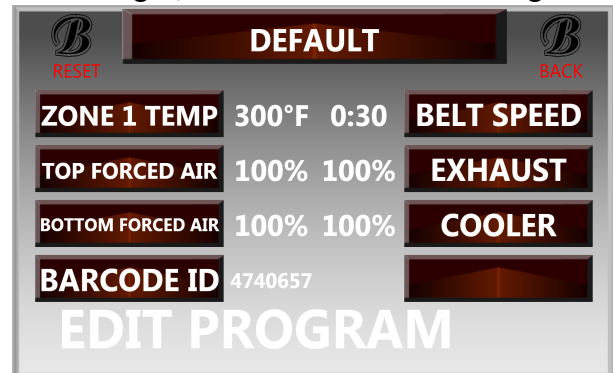

Figure 5: Default Program Screen

Bulb Control Modes:

The Firefly Curing System has several modes it can use to control how the bulbs react to temperature readings from product passing through. Each mode has its own advantages, and can be selected at each drone computer. To select a bulb control mode for a particular drone, press the “Settings” button (Figure 6) on the drone’s main computer screen, then choose “Factory Setup” (Figure 7), and then “Belt Setup” (Figure 8).

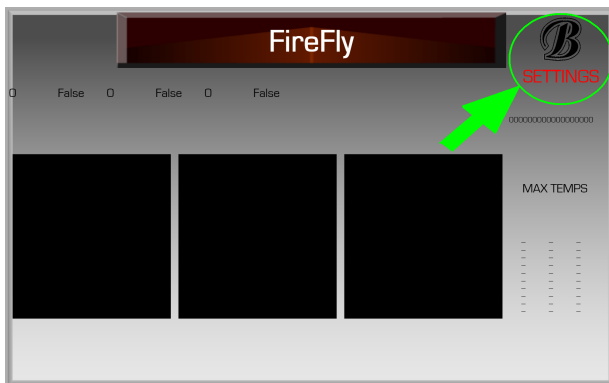

Figure 6: Drone Settings Button

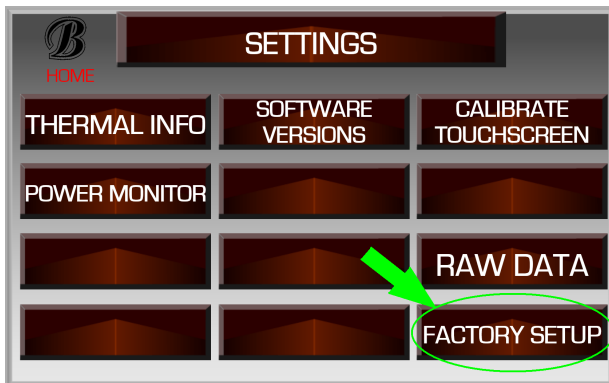

Figure 7: Factory Setup Button

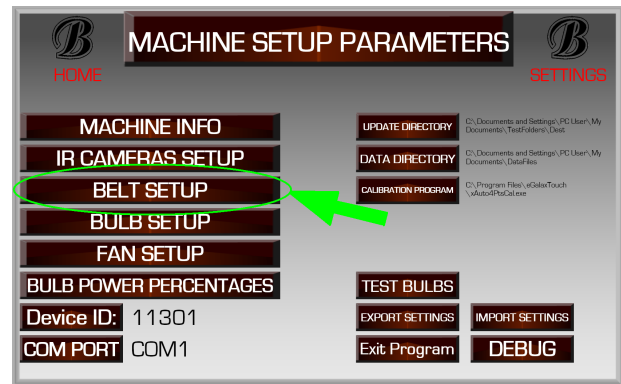

Figure 8: Belt Setup Button

Each belt (also called a “zone”) can be controlled independently by selecting from the zone drop-down menu at the top of the screen (Figure 9). The Bulb Control Mode is shown along with several other setup parameters on this screen, and can be changed by pressing on the “BULB CONTROL” button (Figure 9).

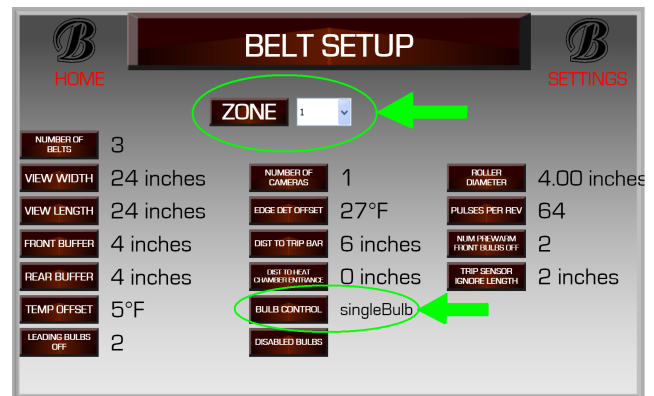

Figure 9: Bulb Mode Button

The available control modes are as follows:

singleBulb:

In this mode, when the product has reached cure temperature in a bulb’s heating area (Figure 10), that bulb is turned off until the product drops back down below cure temp. All adjacent heating areas operate independently.

tripleBulb:

In this mode, when the product has reached cure temperature in a bulb's heating area (Figure 10), that bulb is turned off, along with the bulb in front AND the bulb behind the heating area. This ensures that the bulbs in front and behind do not continue to heat the area that has already reached cure temperature.

This mode is best used when the belt is running very slow, and ensures a minimum amount of temperature overshoot on the product. However, it also reduces the overall speed of cure, since more bulbs are off for longer periods of time than in other control modes.

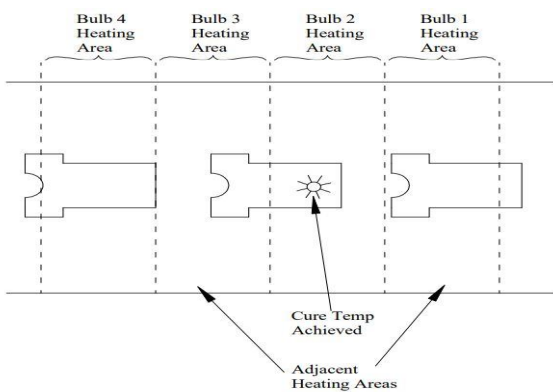

Figure 10: Bulb Heating Areas

twoBulb:

This mode works similarly to tripleBulb, but it turns off only the bulb in question and the bulb in front – not the bulb behind the area at temp.

This mode is best used when the product is running at medium speeds, and it is desirable to reduce temperature overshoots.

leadingBulb:

In this mode, when the product has reached cure temperature in a bulb's heating area (Figure 10), the next bulb in line is turned off until the product drops back down below cure temp. The bulb above the heating area in question is not turned off.

This mode is best used when a product is running at high speed, where bulbs must be controlled in anticipation of the product arriving, rather than reacting to the product already in their heating area.

Prewarm Settings:

The Firefly Curing System has a flexible prewarm feature, which allows the user to set two different levels of pre warm and cool-down.

These settings are accessed through the main control kiosk by going to “Settings”→ “Advanced Settings” → “Factory Setup” → “Zones”. Preheat settings for each zone are shown in Figure 11.



Figure 11: Prewarm Settings

Cold Preheat:

This controls the amount of time (in seconds) the dryer will preheat after it has been fully cooled.

Warm Preheat:

This setting controls the amount of time the dryer will preheat if it is still warm (not fully cooled). This time should be set shorter than the Cold Preheat time.

Cold After:

This controls the amount of time it takes for the dryer to fully cool-down (inactive). This should be set to have the longest cool-down time.

Warm After:

This controls the amount of time it takes for the dryer to moderately cool-down (idle). In other words, it is no longer hot (active), but it has not fully cooled (inactive). This time should be set shorter than the Cold After time.

The prewarm time directly affects the cure quality for a product and the products to follow. The longer the prewarm time, the closer the system will get to reaching a product's target temperature. It also reduces the cure variation between products using the same program. The disadvantage is that some production time will be lost at the beginning of each run (program switch). Short prewarm times are beneficial in situations where programs are consistently being switched.

Similarly, the longer cool-down times (Cold After and Warm After), the more accurate the temperature will be to its target value. Shorter cool-down times are applied if the majority of products use the same program or if there is a small gap between program temperatures. Longer cool-down times are beneficial if there is a large temperature gap between programs. For example, a program is changed to one that is 60 degrees lower. A short cool-down time would not give the system enough time to reach the lower target temperature. This would cause the first few products to be inaccurately cured, each at varying temperatures. The disadvantage to having long cool-down times is that the belt will need to stop more frequently to execute prewarm cycles.

To summarize, using short preheat times (5-10 seconds) and short cool-down times (10-20 seconds) can be beneficial in situations where

there are a large number of short runs. In other words, after a program change, only a few products need to run through before the program needs to be switched again. Long preheat times (10-30 seconds) and cool-down times (30-120 seconds) are beneficial in situations where there are a small number of long runs. Meaning a lot of products can be sent through using one program, thus programs do not need to be switched as often.

Object Detection:

The Firefly Curing System uses sensors at the front of the heat chamber to detect objects entering the dryer (Figure 12)

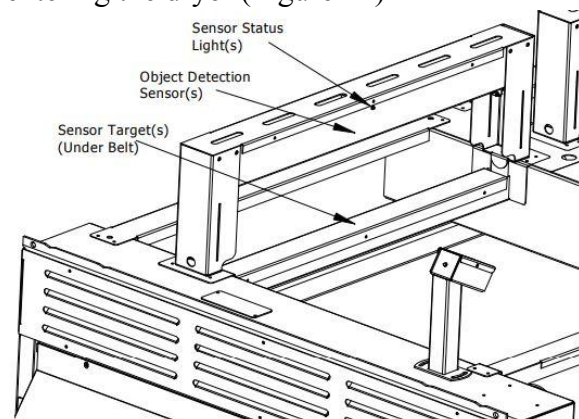

Figure 12: Object Detect Sensor(s)

Objects entering the chamber MUST trip the sensor in order for the dryer to operate correctly. Undetected products will not activate the machine, and may result in uncured or under cured ink.

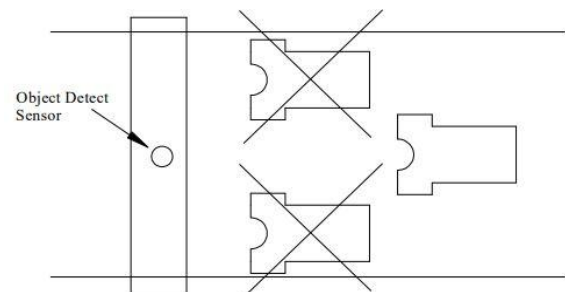

Figure 13: Tripping Object Detect Sensor

The object detect sensor works by shining an invisible (Infrared) beam of light down through

the belt, and detecting the reflection off a target located below the belt (Figure 14).

As an empty belt travels around the dryer, the target is detected, the sensor status light illuminates, and the machine knows that no product is entering the cure chamber.

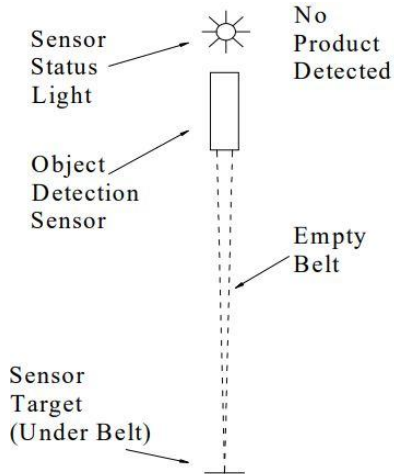

Figure 14: Object Detect Sensor Empty Belt

When a product is laid on the belt and travels under the object detection sensor (Figure 15), it covers the target and the sensor status light turns off. The machine now knows that product is entering the heat chamber, and activates the heating elements.

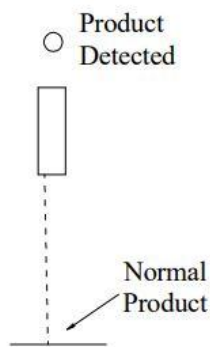

Figure 15: Object Detect Sensor Normal Product

It is important that both the sensor lens and the sensor target are kept free of dust and lint so the light beam can be emitted and detected correctly. If dust or lint blocks the light beam enough, product may be detected even on an empty belt causing the bulbs to activate when they are not needed. This then results in lower efficiency and reduced bulb life.

In rare circumstances, reflective products can be mistaken as the sensor target. Imitating the function of the sensor target, the product reflects the IR light beam back to the object detection sensor (Figure 16). In this case, the sensor status light remains illuminated, showing that the machine is continuing to detect the sensor target, and has not detected the product. Since the system fails to see the product, the bulbs are never activated, which causes the product to remain uncured. While this situation is extremely rare, it is conceivable and should be taken into account when loading product on the conveyor. If possible, reflective portions of the product should be laid to the side of the belt away from the object detection sensor's light beam. If the situation cannot be avoided, contact Brown Manufacturing for further assistance. Additional mitigation steps include changing sensor parameters or in extreme cases changing the type of sensor used for object detection.

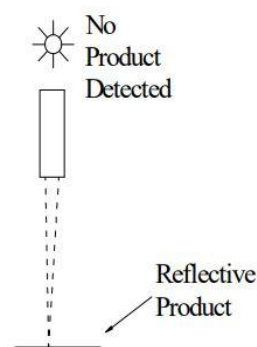

Figure 16: Object Detect Sensor Reflective Product

Load Detect:

The Firefly Curing System uses sensors at the front roller (Figure 17) to detect products loaded onto the belt and assign cure parameters.

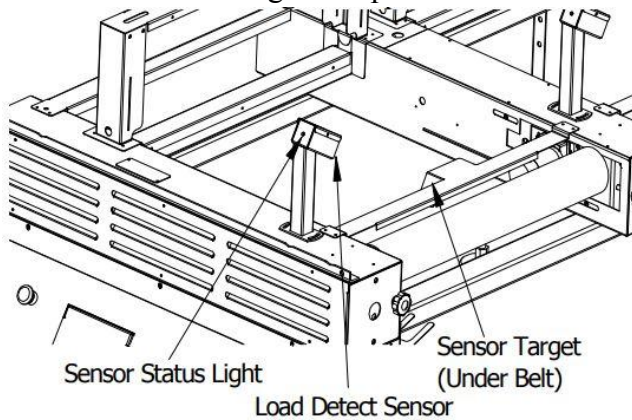

Figure 17: Load Detect Sensor(s)

The system works by detecting a product covering the load detect target (Figure 18). As the product is detected, the machine applies the current active cure parameters to the product. When the back edge of the product is detected (the sensor target is no longer covered), the system locks the cure parameters to that location of the belt. If the user chooses to change the cure parameters, the new program only applies to areas of the belt AFTER the trailing edge of the last product (Figure 18).

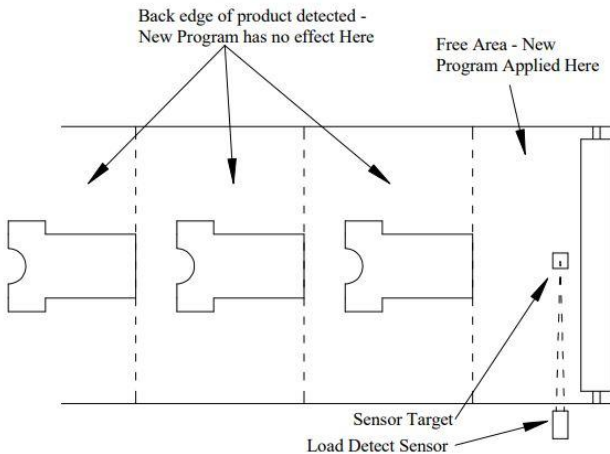

Figure 18: Applying New Program Settings

It is important to remember that new program settings are only applied to new products. Products that have already completely passed the

load detect sensor are not affected by program changes.

Loading Product from Side of Belt

If a product is loaded from the side such that it does not cover the load detect target, then the machine does not know the product has been loaded. The machine will consider the entire belt to be a free area, and will apply new program settings to the entire belt as soon as the settings are changed. In this case, if the program settings need to be changed for a new job, then the last product of the original job should be loaded at the load detect sensor.

Proper Loading Technique:

To ensure proper operation of the Firefly Curing System, it is necessary to load product on the belt correctly.

Snags

It is important that all products are loaded within the edges of the belt. There can not be any parts of a product hanging off the side (Figure 19). Anything outside the belt edges could get caught while traveling through the heat chamber creating a fire hazard. Any snags should be dealt with immediately.

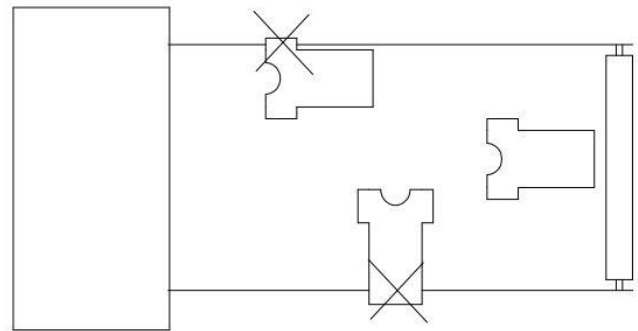

Figure 19: Poorly Loaded Belt

Wrinkles

Product laid on the belt should be as flat as possible. Avoid large wrinkles (Figure 20) that could create shadows in the troughs between

peaks. These shadows lead to uncured sections on a product.

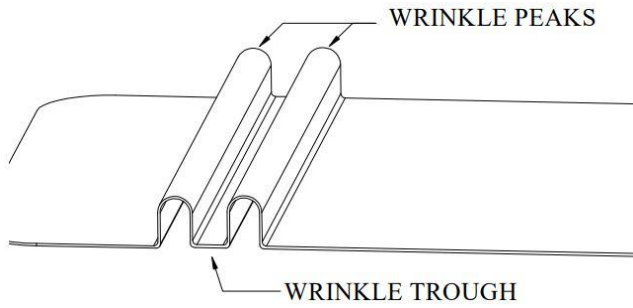

Figure 20: Wrinkled Product

Folds

Do not fold products where there is freshly printed ink. Any ink located inside a fold will not be exposed to IR radiation in the dryer, and will not cure (Figure 21). That being said, areas that do not contain ink can be folded.

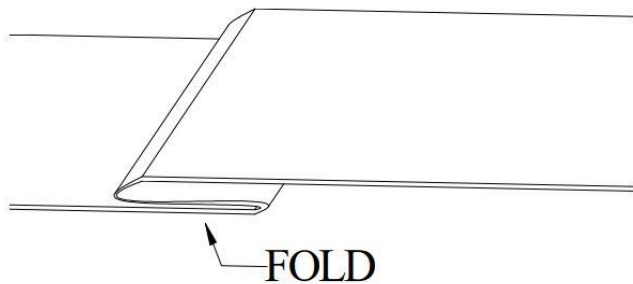

Figure 21: Folded Product

Height Sensor Adjustment:

Each belt has a height sensor system (Figure 22) located in front of the heat chamber to detect and prevent oversized objects from entering the chamber.

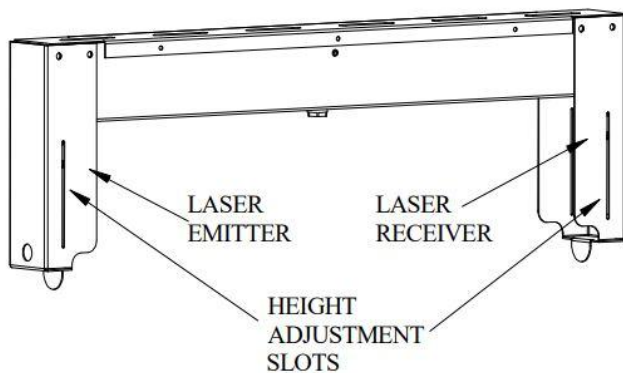

Figure 22: Height Sensor Adjustments

The system consists of a laser emitter on one side of the belt, and a laser receiver on the other. When an object blocks the laser beam from hitting the receiver, a height sensor event is triggered, stopping the belt. When this occurs, a notice appears on the main control kiosk (Figure 23), along with a barcode. The belt can be restarted by pressing the notice on the main control kiosk, by scanning the barcode on the notice, or by scanning a “reset height sensor” barcode printed from the “Settings” Screen (Figure 24)

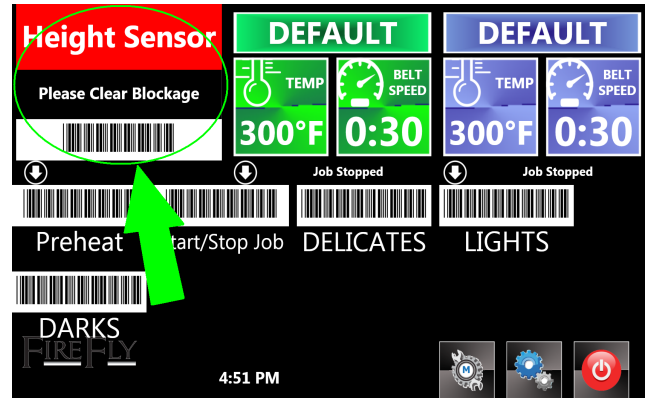

Figure 23: Height Sensor Event Notice

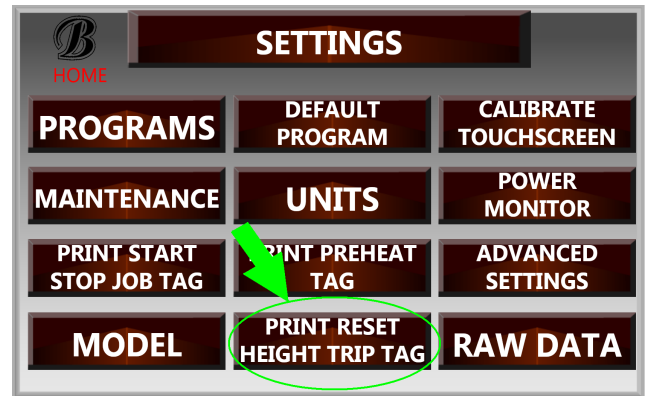

Figure 24: Print Reset Height Sensor Barcode Button

The height sensor system may be adjusted to increase or reduce the allowable object height. Adjustment is accomplished by loosening the screws holding the laser emitter and receiver in their adjustment slots (Figure 22), moving the components up or down, and retightening the screws. Adjust the emitter and receiver as necessary such that the laser beam hits the center of the receiver, and the yellow light on top of the

receiver glows. If the yellow light on the receiver does not glow, or blinks, it is not receiving the laser beam correctly, and one or the other component must be adjusted.

Editing Program Barcode IDs

Programs are created by changing parameters on the main control kiosk. When a new program is saved, a unique barcode ID is created and associated with that program. If it is necessary to change this barcode ID (to match another Firefly Curing System, an order tracking system, etc.), it can be changed using the Edit Program screen.

On the main control kiosk, choose "Settings" (Figure 25), then "Programs" (Figure 26).

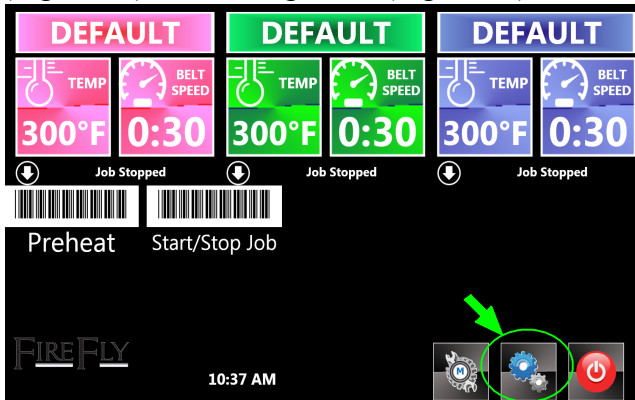

Figure 25: Settings Button

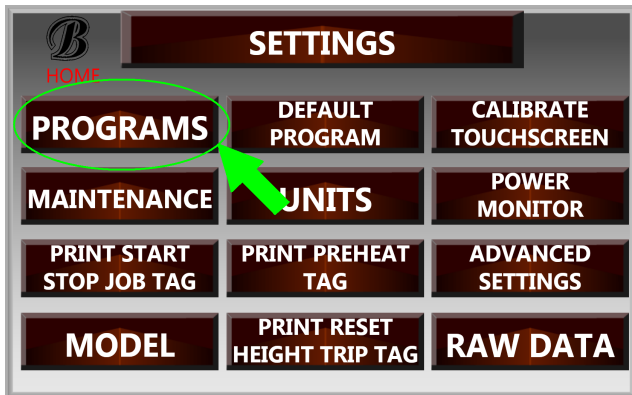

Figure 26: Programs Button

Find the program you wish to edit, and drag it to the "Edit" icon at the bottom of the screen (Figure 27). The "Edit Program" screen will open, allowing the barcode ID to be set (Figure

28). Valid IDs must fall between the numbers 1,000,000 and 9,999,999

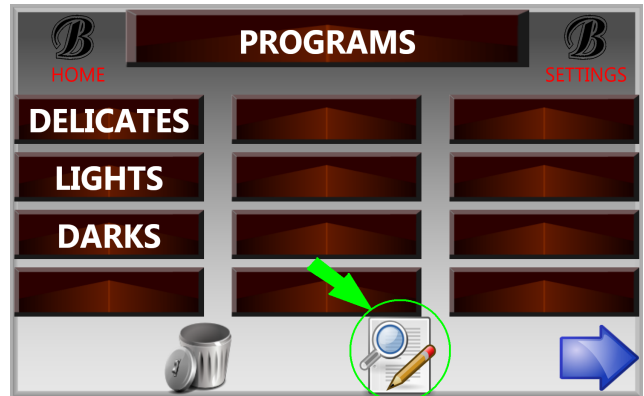

Figure 27: Edit Icon

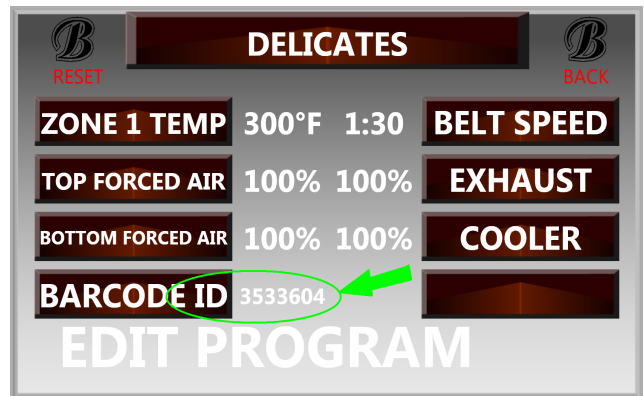

Figure 28: Edit Barcode ID Button

Troubleshooting Common Problems:

Problem: *Bulbs turn on when no product is passing through the dryer*

Solution: Object detect sensors or targets are dirty (See *Object Detection*)

Problem: *Bulbs do not turn on when product passes through the dryer*

Solution: Product did not trip object detect sensors (See *Object Detection*)

Problem: *Product takes a long time to reach cure temperature*

Solution: Bulb powers (especially front bulb powers) may be turned too low. (See *Bulb Program Settings -> Bulb Powers*)

Bulb control mode may be incorrect for speed of belt (See *Bulb Control Modes*)

Problem: *Temperature overshoot on product is causing problems.*

Solution: Bulb powers may be turned too high. (See *Bulb Program Settings -> Bulb Powers*)

Bulb control mode may be incorrect for speed of belt (See *Bulb Control Modes*)

Problem: *Product is snagging in dryer*

Solution: Belt is being loaded incorrectly. (See *Loading Belt Correctly*)

Problem: *Burn marks are appearing on product*

Solution: Oversize product may be touching bulbs due to height sensor being set too high. (See *Height Sensor Reset and Adjustment*)

Problem: *Height sensor is constantly tripping*

Solution: Height sensor may be set too low/sensors are not lined up. (See *Height Sensor Reset and Adjustment*)

Problem: *Prewarm times are annoying*

Solution: Prewarm settings may be inappropriate for your type of use. (See *Prewarm Settings*)

Problem: *Ink not cured on random parts of print*

Solution: Ink may not have been exposed to heating elements correctly. (See *Loading Belt Correctly*)

Problem: *Back of product is not drying*

Solution: Bottom convection air may be necessary. (See *Program Settings -> Convection Top & Bottom*)

LIMITED WARRANTY FOR BROWN AND BROWNDIGITAL EQUIPMENT
Parts and Screens, Inc., dba Brown Manufacturing Group, Inc., 4661 Stafford Ave. S.W., Wyoming, MI 49548

WHO IS COVERED

- This limited warranty (“warranty”) is given only to the original end-use purchaser (referred to in this warranty as “Original Purchaser”) of the accompanying product (collectively referred to in this warranty as “this Product”).
- If you purchased a product from someone other than an authorized Brown reseller in the United States or if the product was used (including but not limited to floor models or refurbished product) prior to your purchase, you are not the Original Purchaser and the product that you purchased is not covered by this warranty.

WHAT IS COVERED

- This Product includes the machine (the “Machine”) specified herein.
- This warranty applies only to Products purchased and used in the United States. For Products purchased in, but used outside, the United States, this warranty covers only warranty service within the United States (and does not include shipping outside the United States). International users are responsible for all technician time and expenses incurred for onsite repairs, both in and out of warranty. Brown will determine whether a part requires factory inspection and the customer is responsible for all freight incurred.

WARRANTY OF BROWN WORKMANSHIP AND MATERIALS

Except as provided below, Brown Manufacturing Group, Inc. warrants to the Original Purchaser for a period of one (1) year from the date of installation, that the solid state electronic components manufactured by Brown and included in the Machine equipment purchased from Brown, or an authorized Brown reseller, were delivered free from defects in materials and workmanship, excluding mechanical or electro-mechanical components including, but not limited to, switches, motors, and solenoids. The foregoing warranty is given only to the Original Purchaser which purchased the equipment (including the component(s) claimed to be defective) directly from Brown, or an authorized Brown reseller in the United States, and are not transferable.

WHAT IS THE LENGTH OF THE LIMITED WARRANTY PERIODS

The following parts of the Machine have the following limited warranty: (i) full machines are warranted for (1) year from the date of Installation; (ii) calrod™ style heaters warranted for a period of three (3) years from the date of installation. (iii) registration gates are warranted for seven (7) years from the date of Installation.; (iv) Machine chassis are warranted for fifteen (15) years from the date of Installation: frames, rollers, linear rails, bearings, gears (plastic and metal) with this Product purchase.

WHAT IS NOT COVERED

This warranty does not cover:

- (1) Physical damage to this Product;
- (2) Damage caused by improper Installation, improper or abnormal use, misuse, neglect or accident (including but not limited to transporting this Product without the proper preparation and/or packaging).
- (3) Damage caused by another device or resulting from use of non-Brown authorized parts and Consumable and Accessory Items.
- (4) Damage caused by non-compliance with the use and operation provisions of the product as outlined in the instruction manual;
- (5) Damage caused by non-compliance with the maintenance provisions of the product instruction manual;
- (6) Damage caused by non-compliance with the printing procedures of the product instruction manual;
- (7) Consumables;
- (8) Accompanying accessories;
- (9) Problems arising from other than defects in materials or workmanship; and
- (10) Normal periodic maintenance items, including but not limited to, head supports or struts, fan filter, nozzle filters, pumps, nozzles, squeegee assemblies and knobs.

This warranty is VOID if this Product has been altered or modified in any way (including but not limited to attempted warranty repair without prior written authorization from Brown and/or alteration/removal of the serial number).

OTHER ITEMS NOT COVERED BY THIS WARRANTY

In addition to the foregoing, this warranty does not apply to: (1) defects resulting from fire, explosion, or water, or from earthquake, windstorm, hail, tornado or other abnormal environmental conditions, or from accident, vandalism; and (2) defects arising from neglect or abuse. Neglect or abuse includes, but is not limited to:

- Use of contaminated, inadequate or excessive amounts of lubricants.
- Exposure to extreme temperatures.
- Improper storage or improper protection from climatic elements and vandalism.
- Accident, collision or other physical mishap or abuse, whether by Original Purchaser or any other party.

WHAT TO DO IF YOU THINK YOUR PRODUCT IS ELIGIBLE FOR WARRANTY SERVICE

Report your issue to Brown’s Customer Service Hotline at [616-249-0200](tel:616-249-0200) within the applicable warranty period. Supply Brown with a copy of your dated bill of sale showing that this Product was purchased from an authorized Brown reseller within the United States.



WHAT BROWN WILL ASK YOU TO DO

After contacting Brown, you will be asked to troubleshoot the problem over the phone. If the troubleshooting does not succeed, you may be required to do one or both of the following:

- (a) Send a component part of the Product properly packaged, freight prepaid, to Brown for inspection, together with a photocopy of your bill of sale. **You are responsible for the cost of shipping, expedited shipping, packing product, and insurance (if you desire). You are also responsible for loss or damage to this Product and its component parts in shipping.** Shipments must be made using a ground carrier that assigns tracking numbers to its shipments.
- (b) Download and send Brown customer usage data to Brown for review via USB drive or another format agreed to by Brown.
- (c) Permit a Brown representative to provide On-Site Warranty Service by providing access to this Product at reasonable times and by providing adequate working space, including heat, light, ventilation, electric current and outlets for use by the Brown representative, together with reasonable cooperation in troubleshooting to diagnose the problem. "On-Site Warranty Service" means remedial service during Normal Working Hours at your location to restore the Product to good operating condition under normal usage at no charge for parts and does not guarantee uninterrupted operation of the Product. Please note that you will be charged labor costs and travel costs for the service. "Normal Working Hours" shall mean 9:00 A.M. to 5:30 P.M. Eastern Standard Time, Monday through Friday, excluding legal and local holidays observed by Brown.

WHAT BROWN WILL DO

If the problem reported concerning your Machine is covered by the warranty **and** if you first reported the problem to Brown within the applicable warranty period, Brown will, at its option, either repair the component(s) or replace the component(s) with a functionally equivalent component(s), including a refurbished part(s) (or arrange for either). Brown reserves the right to supply a refurbished or remanufactured replacement Machine and/or part and use refurbished parts provided such replacement products conform to the manufacturer's specifications for new product/parts. In the case of a component part, if you receive the replacement component part prior to your returning the defective component part, you will replace the defective component part(s) with the replacement component part(s) supplied by Brown and return any claimed defective component part(s) within thirty (30) days of receipt of the replacement component part(s) or pay Brown the list price for each such defective component part(s) not returned within 30 days after receipt of the replacement component part(s). In the case of a replacement Machine, if you receive the replacement Machine prior to your returning the defective Machine to Brown, you will return the claimed defective Machine to Brown within 30 days after receipt of the replacement Machine. Brown will require that you provide a valid major credit card number. Brown may issue a hold against the credit card account number that you provide until Brown receives your original Machine or component part(s) and determines that your original Machine or component part(s) is entitled to warranty coverage. Your credit card will be charged up to the cost of a new Machine or component part(s) only if: (i) you do not return your original Machine or component part(s) to Brown within thirty (30) days; (ii) the problems with your original Machine component part(s) are not covered by the limited warranty; (iii) the proper packaging instructions are not followed and has caused damage to this Product; or (iv) the warranty period on your original Product has expired or has not been sufficiently validated with a copy of the proof of purchase (bill of sale).

If after you replace the defective or failed component(s), the reported problem has not been solved, Brown may determine, at its sole discretion, that On-Site Warranty Service is required or that you should send the component(s) to Brown for further inspection. If Brown determines that On-Site Warranty Service is required, you shall cooperate with Brown as described in the "What Brown Will Ask You to Do" section above. Please note that you will be solely responsible for all zone, hotel and travel expenses associated with Brown's On-Site Warranty Service after the expiration of the limited warranty period described above.

If the Machine is not covered by this warranty, you will be charged any shipping or travel costs incurred by Brown and charged for any service and/or replacement component parts at Brown's then published rates.

The foregoing are your sole (i.e., only) and exclusive remedies under this warranty.

LIMITATIONS

Brown is not responsible for damage to or loss of any equipment, media, programs or data related to the use of this Product. Except for that repair or replacement as described above, Brown shall not be liable for any direct, indirect, incidental or consequential damages or specific relief. Because some states do not allow the exclusion or limitation of consequential or incidental damages, the above limitation may not apply to you.

THIS WARRANTY IS GIVEN IN LIEU OF ALL OTHER WARRANTIES, WRITTEN OR ORAL, WHETHER EXPRESSED BY AFFIRMATION, PROMISE, DESCRIPTION, DRAWING, MODEL OR SAMPLE. ANY AND ALL WARRANTIES OTHER THAN THIS ONE, WHETHER EXPRESS OR IMPLIED, INCLUDING IMPLIED WARRANTIES OF MERCHANTABILITY AND FITNESS FOR A PARTICULAR PURPOSE, ARE HEREBY DISCLAIMED.

- This warranty is the only warranty that Brown is giving for this Product. It is the *final expression and the exclusive and only statement* of Brown's obligations to you. It replaces all other agreements and understandings that you may have with Brown or its representatives.
- This warranty gives you certain rights and you may also have other rights that may vary from state to state.
- This warranty (and Brown's obligation to you) may not be changed in any way unless you and Brown sign the same piece of paper in which we (1) refer to this Product and your bill of sale date, (2) describe the change to this warranty and (3) agree to make that change.
-
-

