





GTX600SB Professional Use

GARMENT PRINTER Setup Manual

Please be sure to read this manual before using this product.
Keep this manual in a safe place for future use.
This printer should only be used by operators who are
appropriately trained in its safe operation.

Table of contents

Please be sure to read "SAFETY INSTRUCTIONS" before use.

	Installation	10
	Setup of the printer	14
	Connection to a PC	38
	Adjustment	44
	Maintenance list	48

SAFETY INSTRUCTIONS

Thank you very much for buying a BROTHER printer. Before using your new printer, please read the "SAFETY INSTRUCTIONS" and handling instructions carefully.



SAFETY INSTRUCTIONS

1. Safety indications and their meanings

This instruction manual and the indications and symbols that are used on the printer itself are provided in order to ensure safe operation of this printer and to prevent accidents and injury to yourself or other people.

The meanings of these indications and symbols are given below.

Indications

 DANGER	The instructions which follow this term indicate situations where failure to follow the instructions will result in death or serious injury.
 WARNING	The instructions which follow this term indicate situations where failure to follow the instructions could result in death or serious injury.
 CAUTION	The instructions which follow this term indicate situations where failure to follow the instructions may result in minor or moderate injury.

IMPORTANT

The instructions which follow this term indicate situations where failure to follow the instructions may result in damage to property.

NOTE

The instructions which follow this term indicate precautions and restrictions for use.

Symbols



This symbol () indicates something that you should be careful of. The picture inside the triangle indicates the nature of the caution that must be taken. (For example, the symbol at left means "beware of injury".)



This symbol () indicates something that you must not do.



This symbol () indicates something that you must do. The picture inside the circle indicates the nature of the thing that must be done. (For example, the symbol at left means "you must make a ground connection".)

2. Notes on safety

DANGER



Contact with high voltage sections may lead to a serious injury. Turn off the power, and remove the cover 5 minutes later.

WARNING

Basic precautions



This printer should only be used by operators who are appropriately trained in its safe operation.



The printer is not suitable for use in places where children are present.



To prevent accidents and problems, do not modify the machine yourself. Brother will not be held responsible for any accidents or problems resulting from modifications made to the machine.



Do not handle the power cord with wet hands. Otherwise, it may cause electric shocks.

Installation



Do not set up the printer in a dusty environment. If dust collects inside the printer, it may cause fire or electric shocks or problems with correct operation.



Be sure to connect the ground. If the ground connection is not secure, you run a high risk of receiving a serious electric shock, and problems with correct operation may also occur.



Do not bend the cords excessively or fasten them too hard with staples or anything similar to secure cords. Otherwise it may cause fire or electric shocks.



Do not connect power cords on the floor near the printer.

Water dripping from the printer may cause fire, electric shocks, or problems.



Printing



If a foreign object gets inside the printer, immediately turn off the power, disconnect the power cord, and contact the place of purchase or a qualified technician. If you continue to use the printer while there is a foreign object inside, it may result in fire or electric shocks or problems with correct operation.











Do not allow the printer to come into contact with liquids. Otherwise it may cause fire or electric shocks or problems with correct operation.











If any liquid gets inside the printer, immediately turn off the power, disconnect the power cord, and contact the place of purchase or a qualified technician.



 WARNING	
Printing	
	Do not use the printer when smoke or a bad odor is coming from the printer. Otherwise it may cause fire or electric shocks or problems with correct operation. Immediately turn off the power, disconnect the power cord, and contact the place of purchase or a qualified technician.
	
	
	Keep your finger or any body part away from the rotating fan. Otherwise it will be caught up, which results in injuries. Turn off the power when you approach the fan.

 CAUTION	
Environmental requirements	
	Use the printer in a place which is adequately ventilated. A slight odor is generated when the printed articles are being fixed by heat.
Installation	
 	The printer machine weighs 690 kg (1521 lb). Transporting and setting up of the printer should be held in the proper way. Otherwise, the printer may topple over and cause injury.

 	Unplug the printer and contact the dealer where you purchased the printer or a trained technician if the printer topples over. If you continue to use it, it may result in fire or electric shocks or poor printing quality.
	Do not set up the printer in a place where it will be affected by vibration. Otherwise the printing quality may be degraded or the printer may topple over, which causes injury or results in failure of the printer.
	Do not connect the power cord until installation is complete. The printer may operate if the power is turned on by mistake, which could result in injury.
	Do not climb onto the printer or place heavy objects on top of it. You may get injured if it becomes unbalanced and tips over.
Printing	
	This printer should only be used by operators who are appropriately trained in its safe operation.
	Ensure there is adequate space left in front of the printer and avoid placing any objects. Otherwise your hand may get caught between the platen and an object, which may result in injury.
	Do not handle the platen while printing. If your hand gets caught between the platen or the T-shirt tray and the covers, it may be injured.
	Do not put your hands inside the covers while the printer's power is turned on. Otherwise your hands may touch against moving parts and this may result in injury.

 **CAUTION****Printing**

When the pretreatment is applied to printed objects (like a T-shirt) with a spray or pretreatment applicator, sprayed mist is generated. So wear a pair of plastic gloves, a mask and protective glasses (or goggles) designed to shield against liquid splash, and fully take care of the air ventilation when you are working with it.



When a problem occurs with the operation of the printer, contact the place of purchase or a qualified technician.



Be careful not to put your hands in the clearance of the cover of the lifting up/down mechanism. Doing so may cause injury.

Maintenance

Be careful not to pinch your fingers when closing each cover. You may get injured if you pinch your fingers.



When you mount or replace the head, be careful not to get your hands or fingers caught. Otherwise you may be injured.



Do not drink liquids such as the ink, cleaning solution, pretreatment, or waste.

They may cause diarrhea or vomiting.

When handling liquids, such as the ink, cleaning solution, pretreatment, and waste, use protective glasses and gloves to avoid causing your eyes and skin to contact the liquids.

It may cause inflammation. In case of contact with eyes, do not rub but immediately rinse the eyes with water.

Keep the liquids out of the reach of children.



Be sure to wear protective goggles and gloves when handling the grease, so that it does not get into your eyes or onto your skin.

It can cause inflammation. Do not drink or eat the grease. It may cause diarrhea or vomiting.

Keep the liquids out of the reach of children.



When replacing parts and installing optional accessories, be sure to use only genuine Brother parts. Brother will not be held responsible for any accidents or problems resulting from the use of non-genuine parts.



When replacing parts or installing optional accessories, be sure to follow the procedures described in the Instruction Manual. Incorrect procedures could cause injuries or problems.



Follow the corresponding instructions in the manual when you put your hands inside the cover during regular maintenance while the power is turned on.

IMPORTANT

Printing



Do not move the platen by hand. Otherwise the printer may be mechanically and electrically damaged.



Ensure there is adequate space left in front of the printer and avoid placing any objects. The platen may be hit and damaged.

NOTE



Use the printer in an area which is free from sources of strong electrical noise such as electrical line noise or static electric noise. Sources of strong electrical noise may cause problems with correct operation.



Any fluctuations in the power supply voltage should be within $\pm 10\%$ of the rated voltage for the printer. Voltage fluctuations which are greater than this may cause problems with correct operation.



The power supply capacity should be greater than the requirements for the printer's power consumption. Insufficient power supply capacity may cause problems with correct operation.



In the event of an electrical storm, turn off the power and disconnect the power cord from the wall outlet. Lightning may cause problems with correct operation.

<About trademarks>

The names of operating systems described in the main context of this manual are abbreviated. Product names used in this manual are, in general, trademarks or registered trademarks of their respective developer or manufacture. However, in this manual, the ® marks or TM marks are not used.

Brother logo is registered trademark of Brother Industries, Ltd. Apple, Macintosh, Mac OS, iOS, OS X, macOS, Safari, iPad, iPhone, iPod and iPod touch are the trademarks or registered trademarks of Apple Inc. in the United States and other countries.

The official name of Windows® 10 is Microsoft® Windows® 10 operating system. (represented as Windows 10 in this manual)

The official name of Windows® 11 is Microsoft® Windows® 11 operating system. (represented as Windows 11 in this manual)

Microsoft®, Windows® 10, and Windows® 11 are trademarks and registered trademarks of Microsoft Corporation in the United States of America and other countries.

Other product and company names mentioned herein may be the trademarks or registered trademarks of their respective owners.

Information in this document and the specifications of this product are subject to change without notice.

<About the CE declarations>

Downloadable from: <https://www.brother.com>

3. Warning labels

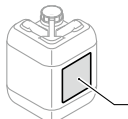
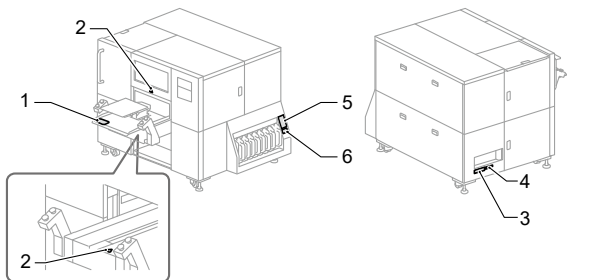

Waste ink tank

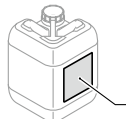

Waste water tank

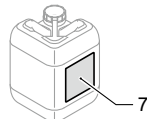

Ink bottle 9 L

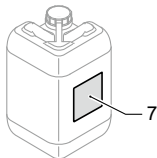

Ink bottle 18 L

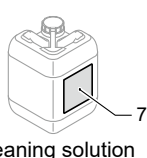

Cleaning solution
Bottle 9 L

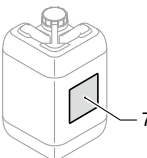

Cleaning solution
Bottle 18 L



Pretreatment
5 kg (11 lb)

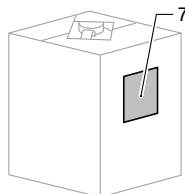

Pretreatment
20 kg (44 lb)

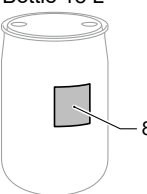

Pretreatment
200 kg (440 lb)

X1177

This printer has the following warning labels displayed on it. Follow the precautions given on each warning label for your work.

When the label is peeled off or illegible, contact the place of purchase.

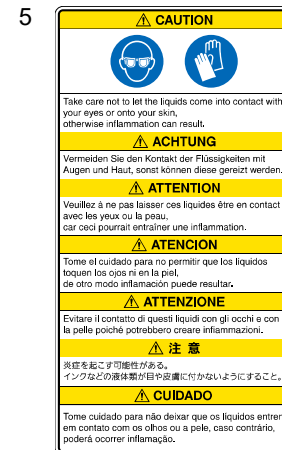
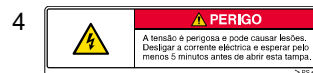
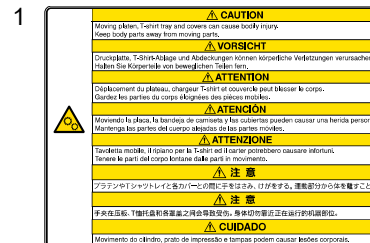











SAFETY INSTRUCTIONS

7

 CAUTION  	 VORSICHT
<p>Do not drink the liquids under any circumstances, as they can cause vomiting and diarrhea. Take care not to let the liquids come into contact with your eyes or onto your skin, otherwise inflammation can result. Keep the liquids out of the reach of children.</p>	<p>Bitte trinken Sie nicht die Flüssigkeiten, da die Gefahr von Erbrechen und Durchfall besteht. Vermeiden Sie den Kontakt der Flüssigkeiten mit Augen und Haut, sonst können diese gereizt werden. Halten Sie die Flüssigkeiten von Kindern fern.</p>
 ATTENTION	 ATENCIÓN
<p>Ne pas avaler les liquides d'aucune manière. Car ceci pourrait entraîner vomissements et diarrhées. Veillez à ne pas laisser ces liquides être en contact avec les yeux ou la peau, car ceci pourrait entraîner une inflammation. Méme les liquides hors de portée des enfants.</p>	<p>No tome los líquidos en cualquier caso, como pueden causar vómitos y diarrea. Tome el cuidado para no permitir que los líquidos toquen los ojos ni en la piel, de otro modo inflamación puede resultar. Mantenga los líquidos fuera del alcance de niños.</p>
 ATTENZIONE	 注意
<p>Non bere per nessun motivo i liquidi poiché possono causare vomito e diarrea. Evitare il contatto di questi liquidi con gli occhi e con la pelle poiché potrebbero creare infiammazioni. Conservare il liquido lontano dalla portata dei bambini.</p>	<p>下痢・お吐きなど可能性があります。インフルエンザなどの液体を飲まないこと。炎症を起こす可能性があります。インフルエンザの液体が目や皮膚に付かないようにすること。子供の手の届かないところに置くこと。</p>
 CUIDADO	 注意
<p>Não beba os líquidos sob nenhuma circunstância, pois eles podem causar vômitos e diarreia. Tome cuidado para não deixar que os líquidos entrem em contato com os olhos ou a pele, caso contrário, poderá ocorrer inflamação. Mantenha os líquidos fora do alcance das crianças.</p>	<p>■ Depositare in conformità con i tuoi regolamenti. ■ Gebrauchte es gemäß örtlicher Richtlinien entsorgen. ■ After conformément à la réglementation locale en vigueur. ■ Después de seguirlo la normativa local. ■ Smaltire in conformità alle normative locali. ■ Depositare em conformidade com os regulamentos locais. ■ 当地の法令に従って廃棄してください。用紙は必ず回収する。</p>

8

      
Use Better
 CAUTION  
<p>Take care not to let the liquids come into contact with your eyes or onto your skin, otherwise inflammation can result. Keep the liquid out of the reach of children.</p> <p>Do not drink the liquids under any circumstances, as they can cause vomiting and diarrhea.</p> <p>Opening the seal cap with bare hands may cause injury. Use pliers to open the seal cap.</p> <p>Heavy strain could cause injury or backache. Do not lift or move the drum without mechanical assistance.</p>
NOTE
Depositare in conformità con i tuoi regolamenti. Do not overtighten.

8

<When you dispose of the machine>

Required Tools

Phillips screwdriver: M3 to M5

Disassembling

1) Remove the Cover of BACK SIDE bottom center.



2) Remove the Lithium Battery (1) by pulling out the holder in the direction of the arrow.

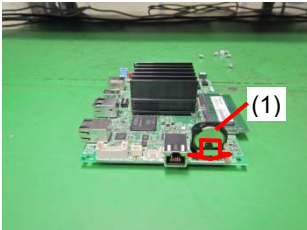

3) Pickup the Lithium Battery (1) to the direction of the arrow.



Note based on California law (USA) on the use and handling of Perchlorate

This product contains a CR Coin Lithium Battery which contains Perchlorate Material – special handling may apply.

See

<http://www.dtsc.ca.gov/hazardouswaste/perchlorate>.

1 Checking the installation site

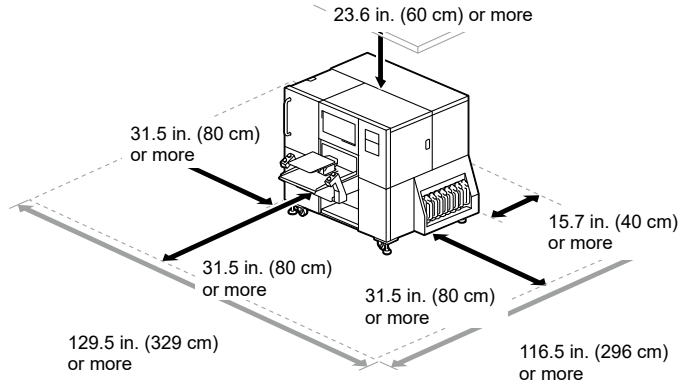

IMPORTANT

The ink bottle for use in the initial installation should be sent in advance to the location where the printer is to be installed and stored indoors.
 *If you use ink at extremely low temperature when the outside temperature is low or in the cold season, the ink becomes hard to flow during ink installation.

● The following environmental requirements should be met:

Environment	Temperature	Humidity
Humidity (%)	0°C (32°F) to 40°C (104°F)	20 % to 85 % (no condensation)
Working Environment ^{*1}	10°C (50°F) to 35°C (95°F)	
Recommended Print Environment ^{*2}	18°C (64.4°F) to 30°C (86°F)	35% to 85 % (no condensation)

Electrical Requirements	Power	Power Consumptions
—	Single-phase 200-240 V, 50/60 Hz	5 A max.

^{*1}: Environmental range where the printer can be operated.

^{*2}: Environmental range where sufficient printing quality can be secured.

2 Unpacking

- When installing the printer, avoid any place that presents direct sunlight or a large amount of dust.
- The size is 73.6 in. (width) x 75.6 in. (depth) x 57.5 in. (height) (187 cm (width) x 192 cm (depth) x 146 cm (height)). The main unit weighs 690 kg (1521 lb).
- Do not use an extension cable.
- Keep a minimum workspace of 31.5 in. (80 cm) in front and on the left and right sides of the printer. Also, keep 15.7 in. (40 cm) or wider clearance at the back of the printer. Keep 23.6 in. (60 cm) or wider space free above the unit. If this space is not secured, you will have to move peripherals or the printer when making a repair.
- When installing the printer, place a level gage on the top surface of the platen to make adjustments so that the main unit is set horizontally.
- When connecting the power cord to the printer, do not use overloaded sockets.

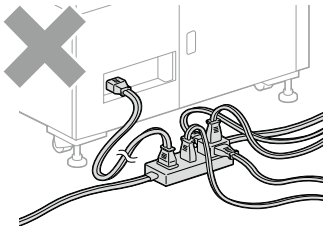

X1153

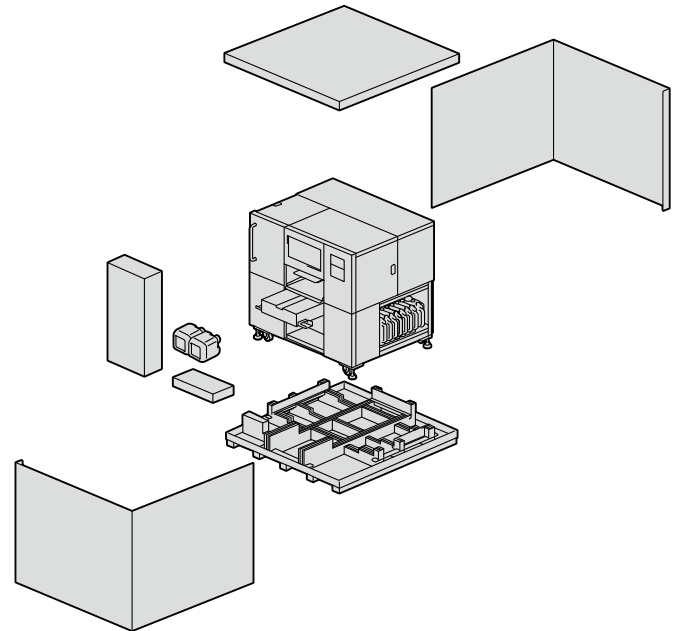

X1118

IMPORTANT

Do not turn on the power until "P.27 Connect the humidifier water supply tube." is completed. Otherwise the printer may fail.

Check the supplied accessories.

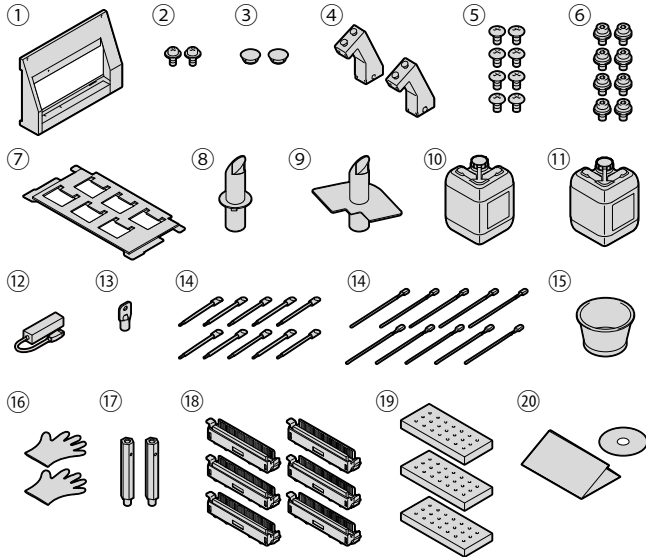

X1157

- ① Main tank cover
- ② Main tank cover installation screw (M4) ×2
- ③ Hole cap (black) ×2
- ④ Print switch unit ×2
- ⑤ Print switch cover installation screw ×8
- ⑥ Print switch unit installation screw ×8
- ⑦ Carriage foam
- ⑧ Humidifier pipe R
- ⑨ Humidifier pipe L
- ⑩ Waste ink tank
- ⑪ Waste water tank
- ⑫ USB hub
- ⑬ Key to printer cover ×6
- ⑭ Clean stick R ×10 / Clean stick T ×10
- ⑮ Cleaning cup
- ⑯ Glove ×4
- ⑰ Cam fixing pin ×2
- ⑱ Wiper blade ×6
- ⑲ Flushing foam ×3
- ⑳ Setup Manual

* The print heads and mist fan filter are attached to the printer before shipping.



TIPS

The administrator should keep the key.

Prepare the following items along with the supplied accessories:

- 9 L Ink bottle
- AC power cord
- Cleaning solution
- Pretreatment

3 Transporting the printer

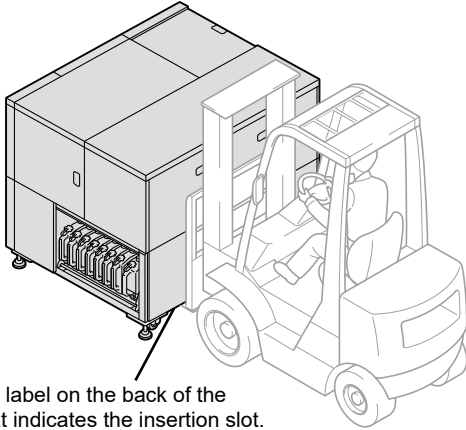

There is a label on the back of the printer that indicates the insertion slot.

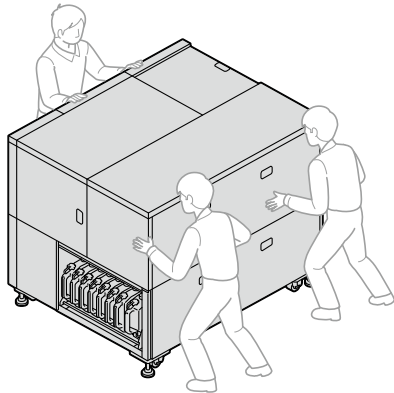

X1120

X1121

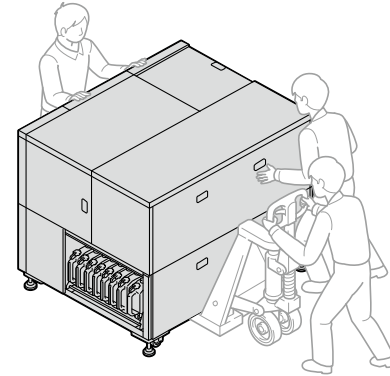

X1122

CAUTION

The printer has a dimension of 73.6 in. (width) × 75.6 in. (depth) × 57.5 in. (height) (187 cm (width) × 192 cm (depth) × 146 cm (height)). The main unit weighs 690 kg (1521 lb). Transporting and setting up of the printer should be held by at least three persons in the proper way. Otherwise, the printer may topple over and cause injury. Be careful not to get your feet caught in the frame, casters, or adjusters under the printer during transportation. Also, check the forward direction and be careful not to get caught between obstacles and this printer. Otherwise, the operator may get injured.

Setup of the printer

1 Removing the protection materials

Remove all the tapes and sheets.

Main body



Cushioning material between tanks

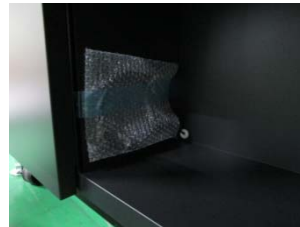

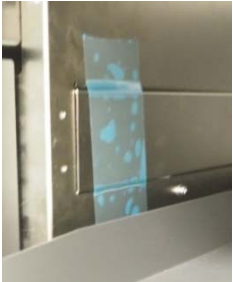
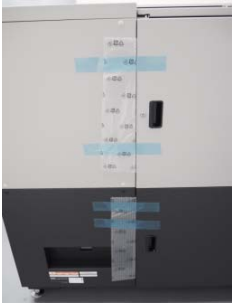

Maintenance

1.



Unlock and open the upper left side cover.

2.

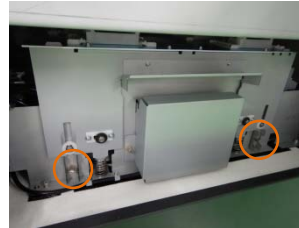

Remove the cap fixing plate with a flat-blade screwdriver.

3.



Keep the cap fixing plate mounted onto the maintenance unit.

4.



Keep the supplied cam fixing pins mounted onto the maintenance unit and close the cover.



In the event of a power failure, the cam fixing pins are required for capping.

2 Mounting the supplied accessories

Mount the supplied accessories according to the following procedures.

Main tank cover

1.



Remove the band and then remove the tube.

2.



Remove the two screws on the side.



The removed screws are required when transporting the printer again.

3.



Loosen the four screws so that the metal fitting will become loose.

4.



Pull out the main tank unit until it comes in contact with the stopper.

5.



Temporarily tighten the supplied two main tank cover installation screws (M4).

6.

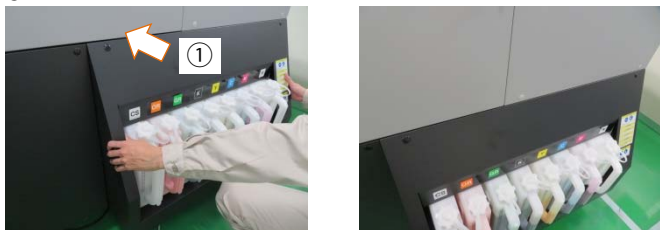

Align the bands provided for the tank caps so that the bands face the front. Then lift and slide the main tank cover in the direction of ① until the main tank cover passes over the tank caps.

IMPORTANT

Be careful not to pinch the tubes.

7.

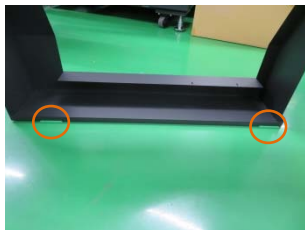

Insert the notch on the main tank cover into the metal fitting loosened in step 3.

8.



Insert the main tank cover firmly to direction ② and securely tighten the two main tank cover installation screws (M4) that have been temporarily tightened and the four loosened screws.

9.



Fit the hole caps (black) into the two screw holes on the main tank cover.

Print switch

IMPORTANT

Install the print switches on the proper side. The side with the hole faces the platen side to allow the wire harness to pass through it.

1.



Check the left and right sides.

2.



Pass the harness of the printer through the hole.

3.



Print switch unit installation screw



Secure the print switch unit with the four print switch unit installation screws from the bottom of the main unit.

(Torque: 2.0 N · m)

IMPORTANT

Do not pinch the harness with the frame and the print switch unit.

4.



Connect the two connectors and insert the harness inside.

5.

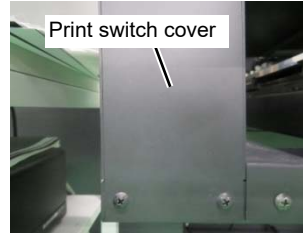

Mount and tighten the cover with the four print switch cover installation screws.

Similarly, connect the other print switch unit.

IMPORTANT

Position the print switch cover in front of the frame and tighten the screws.

Waste ink tank and waste water tank

1.



Open the lower left side cover.



2.

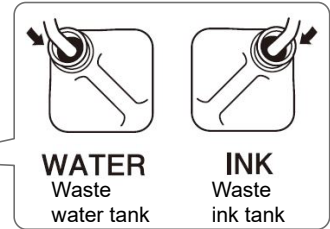

Check the direction of the tank hole and install the tank as shown on the label.

Insert each tube into the tank and close the cover after installation.

X1154

IMPORTANT

Be sure to push the tanks into the back of the cabinet.

Install the tanks so that each tank hole is directly below the tube.
A tank oriented in the wrong direction may not be detected.

Be careful not to bend the tubes excessively. Otherwise, the waste ink will have difficulty flowing through the tube and may lead to a malfunction.

Store the waste ink tank and waste water tank caps for future use (do not discard).

Setup of the printer

Humidifier pipe

1.

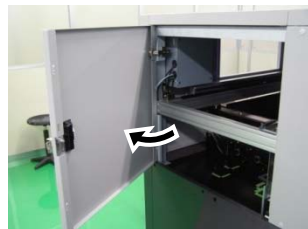

Unlock and open the right-hand-side cover.

2.

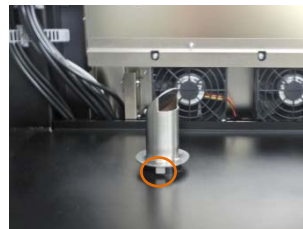
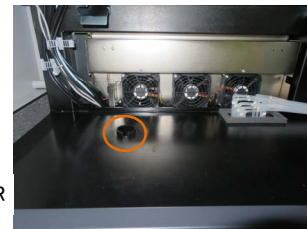
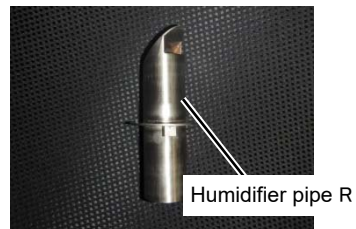

Attach the humidifier pipe R.



Attach the humidifier pipe R so that its tab fits into the groove on the pipe on the printer.

3.



Unlock and open the upper left side cover.

4.



Humidifier pipe L



Insert the humidifier pipe L from the side of the maintenance unit.

5.



Attach the humidifier pipe L.

6.

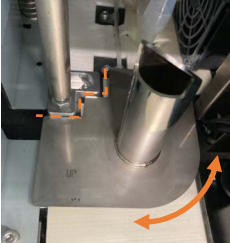

Move the humidifier pipe L from side to side to ensure it does not move significantly.

IMPORTANT

An incorrect installation angle of humidifier pipe L can lead to internal rust in the product. Always make sure it is correctly installed.

3 Carriage belt tension adjustment

IMPORTANT

Adjust the carriage belt tension at a room temperature of 18°C to 30°C.

1. Turn off the power.

2.

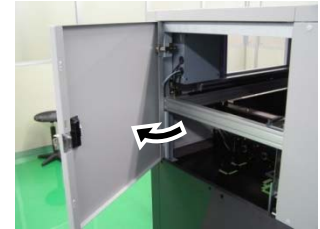

Unlock and open the right-hand-side cover.

3.

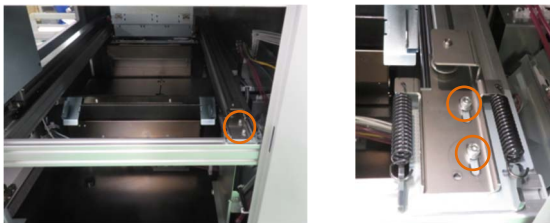

Loosen the two bolts on the carriage belt holder.

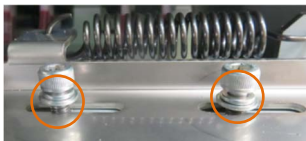

IMPORTANT

Loosen the two bolts until there is a gap between each bolt's face and the part.

4. Tighten the two carriage belt holder bolts to 3.5 N · m.

4 Connecting the humidifier water supply tube

About the water used

Use pure water.

IMPORTANT

If non-pure water, such as tap water, is used, white powdery impurities will adhere to the inside of the unit, causing damage to the printer and heads.

Electrical conductivity of Pure water have to be less than 10 μ S/cm.
For the measurement method, contact the dealer where you purchased the printer.

Water supply

Optional items

- Water tank supply ASSY
- Water tube T6040 15M
- L-shaped fitting 06-06

Commercially available item

- Regulator
- Pure water equipment

If supplying from a water pipe

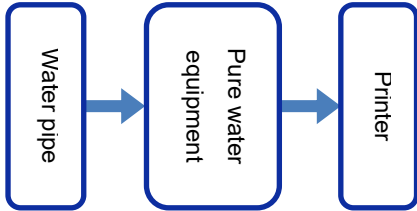

NOTE	If supplying from a water pipe, perform piping according to the applicable laws and regulations.
	If necessary, use a regulator so that the supply pressure will be 40 kPa or less.

If supplying from a tank

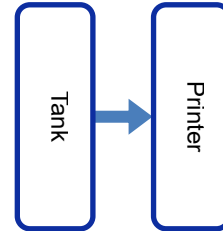

IMPORTANT	Fill the tank with pure water.
	Use a clean container to supply water to the tank.
	Install the tank about 31.5 in. (80 cm) above the installation location of the printer. If the height is insufficient, water may not be supplied to the printer.
	The tube should be laid on the floor, and the length should be 49.2 feet (15 m) or less. Lay the tube so that there is a height difference of about 5.9 in. (15 cm).
	Limit the number of L-shaped fittings (06-06) to three per flow path.

IMPORTANT

Be sure to mount a cable cover with sufficient strength to the tube.
Water will not be supplied and may leak to the floor if the tube is broken or cut off.

Lay the tube so that the bending radius is 2.0 in. (5 cm) or more.
If the bending radius is small, the tube may break.

If the tube is broken during laying, do not use the broken part.

Do not use the optional humidifier water supply tube to connect to tap water piping.

Use a new tube.
No water may be supplied if you use a tube with residual water inside.

Loosen the tank's cap during use.

Verify that the cock is in the closed position before inserting or removing the tube. Failure to do so could allow the water to flow out of the tank.

Check inside the water tank once a month.
Clean inside the tank if you notice any bad odor or discoloration.

Connect the humidifier water supply tube.

1.



Loosen the two screws on the lower left-hand-side cover on the right-hand side of the printer.

2.



Remove the two screws and remove the cover.

3.



*Remove this tube in the case of using a tube with a connection diameter of 4 mm.

Insert the humidifier water supply tube into the outlet marked WATER.

NOTE

Make sure to insert it to the end.



TIPS

Connectible tubes are those with an outer diameter of 4 mm or 1/4 inch.

Install the removed cover, tighten the screws, and mount the cap.

IMPORTANT

Be careful not to pinch the tubes.

Disconnecting the humidifier water supply tube

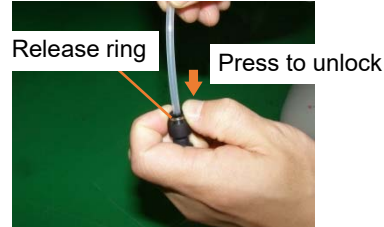

Press the release ring to unlock and pull out the tube.

Supplying from a tank

1.



Humidifier filter

Install the humidifier filter.

2.



Insert the tube and open the faucet.

NOTE

Make sure to insert the tube to the end.

Verify that the cock is in the closed position before connecting the tube to the tank.

Fill the tank with water until it is about 80% full.

Disconnecting the tube or plug

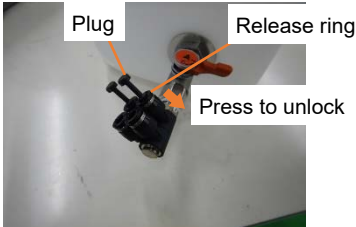

Press the release ring to unlock and pull out the plug.

 TIPS	When using two or more printers, unplug and insert the tube.
	Be careful when unplugging, as the plug can be stiff.

5 Turning on the power

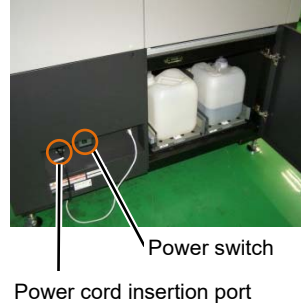

Insert the power cord into the power cord insertion port and plug the cord into an electrical outlet. Turn on the printer power switch with each door and cover closed.

IMPORTANT	Make sure that the printer's earth terminal is properly grounded.
------------------	---

6 Adjusting the levelness

1. Press  to move the platen to the front.

2.

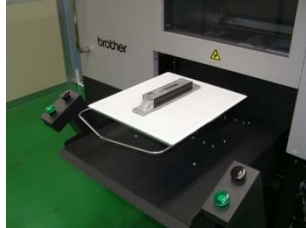
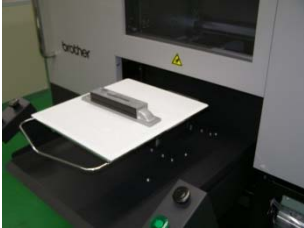

Apply a level to the center of the platen.

3.

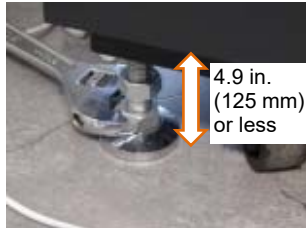

Adjust the level by rotating the lower nuts that secure the legs (4 points).

IMPORTANT

Adjust so that the adjusters protrude 4.9 in. (125 mm) or less from the bottom of the frame.

4.



Tighten the upper nut upwards after adjusting the level.

IMPORTANT

Check the level again after adjusting the legs.

7 Refilling the ink and cleaning solution

Turn ON the power of the printer and perform the operation while the printer is in Standby mode.
If there is new firmware, update the printer.

CAUTION

Be sure to wear a pair of plastic gloves and protective glasses while refilling the ink.



IMPORTANT

Agitate the white ink before refilling.
For details, refer to the Instruction Manual.



TIPS

When agitating the white ink, remove the IC stick from the refill ink bottle to prevent the IC stick from falling off.

- 1)  -> [Ink refill] -> Select the ink color and cleaning solution you want to refill -> 
- 2) Insert the IC stick of the same color as the ink to refill ->



TIPS

An error appears if you insert an IC stick of a different color.

Handle the IC stick with care.

- 3) Refill the ink and cleaning solution.



IMPORTANT

Be sure not to refill the ink or cleaning solution above the upper graduation mark in 6.
Before initial ink installation, fill the white ink or cleaning solution to around the upper graduation mark in 6. For color or OR/GR ink, fill to around the upper graduation mark in 4.
If the ink quantity is too low, the initial ink installation may not start.

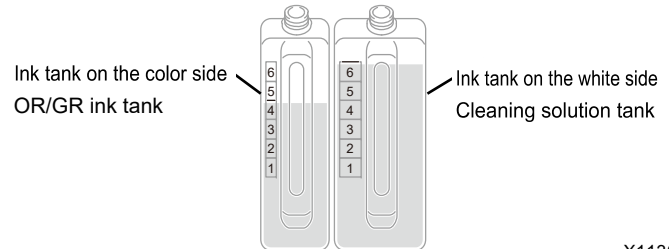

4) Follow the instructions on the screen.

IMPORTANT

Be sure to close the tank lids once you have refilled the ink and cleaning solution.

To store the ink valve after use, wipe off the ink with a waste cloth and seal it in a plastic bag. Do not use a non-standard funnel. Use the provided valve. Otherwise, ink may be contaminated or deteriorated, possibly damaging the printer.



IMPORTANT

Take care not to lose the IC sticks that come standard with the refill ink bottle and cleaning solution bottle.

Store the respective IC sticks by attaching them to the handles of the corresponding refill ink bottle and cleaning solution bottle.



Waste should be disposed of in accordance with regulations and laws.

8 Mounting the wiper

1.  -> [Maintenance] -> [Maintenance Part Clean/Replace] -> [Replace maintenance unit parts] ->

2. 

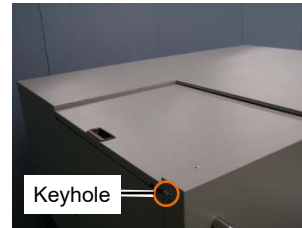

Unlock the upper left-hand-side cover and top cover and open them.

3.

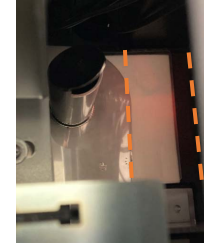
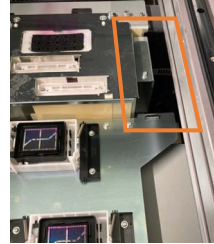
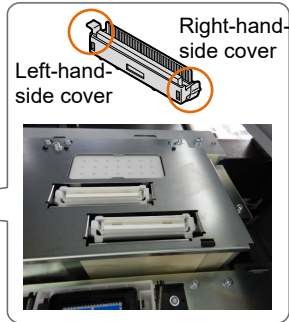
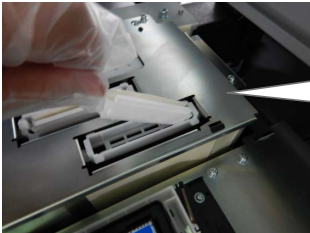
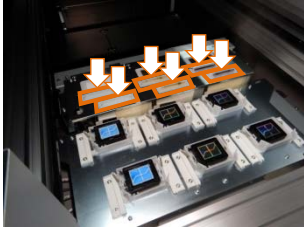

NOTE

When uncapping, look from the front side of the wiper unit to check if the humidifier pipe L is correctly installed.

Hold the latch of the wiper on the left-hand side and insert the wiper into the maintenance unit from the right-hand side. X1155

IMPORTANT	Be sure to connect the wiper in the right direction.
	Push the wiper in and make sure that the left and right protrusions are firmly fitted.
 TIPS	There may be some ink marks from the finished product inspection.

9 Mounting the flushing foam



Mount the flushing foam onto the maintenance unit.

IMPORTANT

After this assembly process is completed, make sure that no flushing foam extends off the outboard end portions of the maintenance unit. If it sticks out of the end portions, it may interfere with any nozzles and may result in non-ejection of ink-jet droplets.

10 Mounting the carriage foam

1.

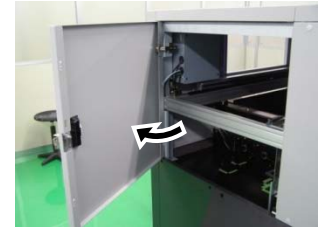

Unlock and open the right-hand-side cover.

2.

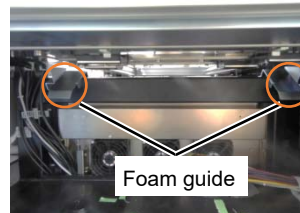

Mount the carriage foam onto the sliding surface of the foam guide.

3.

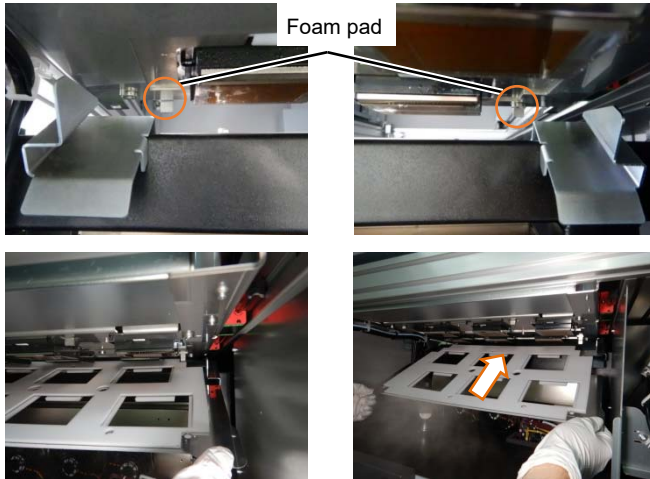

Move the carriage foam along the sliding surface of the guide in the direction of the arrow until the carriage foam comes in contact with the foam pad (two places).

4.

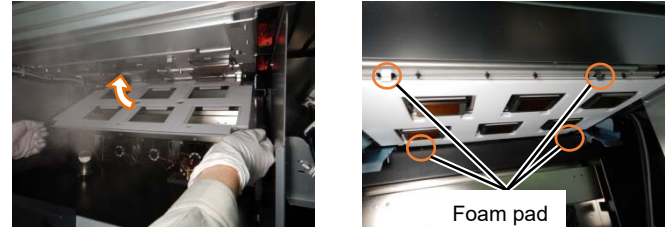

Rotate the carriage foam and attach it to the magnet.
Make sure the carriage foam is not on the foam pad.

IMPORTANT

Be careful not to let the carriage foam come into contact with the nozzle surface of the head.



5.



Make sure that the nozzle surface is below the lower surface of the foam, close the cover, and follow the screen to return the printer to the standby state.



11 Configuring the language

Perform the operation while the printer is in Standby mode.

- 1)  -> [Language] -> Select your language -> 
- 2) Press the power button to turn off the power.

12 Installing the ink

Turn ON the power of the printer and perform the operation while the printer is in Standby mode.

- 1)  -> [Maintenance] -> [Initial Ink Installation] -> [All Print Heads]
- 2) Follow the precautions on the screen and press 
(it takes about 120 minutes and further takes about 30 minutes if below 18°C (64.4°F)).
- 3) When the printer returns to Standby mode, the operation will be completed.

Connection to a PC



Although the description of this section is based on operation with Windows, you can also use Macintosh.
For details, refer to the Instruction Manual.

1 Installing the driver

- 1) Download the ZIP file from our website and unzip the file.
- 2) Double-click on "setup.exe" -> Activate the installer.
- 3) Follow the instructions on the screen.
- 4) After the installation, restart the PC.

2-A When connecting via USB

- 1) Connect the printer and PC via a USB3.0 cable.



Use the USB 3.0 cable that comes with the printer.
Do not use any extension cable.

- 2) Follow the instructions on the screen.



This screen may prompt more than once.
And this also may require several minutes to complete.

We recommend that you set "Brother GTX-6 Extra Colors ORGR" or "Brother GTX-6 Extra Colors ORGR FileOutput" as the default printer for your convenience.

2-B When connecting via LAN

Assignment of printer static IP address



TIPS

The printer may not be recognized depending on your security environment. Consult the system administrator of the setting site.

The static IP address can also be set on the printer. For details, refer to the Instruction Manual.

- 1) Perform the procedures of "When connecting via USB" on P. 38.
- 2) Start menu -> "Brother GTX-6 Extra Colors ORGR Tools" -> Activate "GTX-6 Extra Colors ORGR Maintenance".
- 3) Select [Set an IP Address] -> [Next].

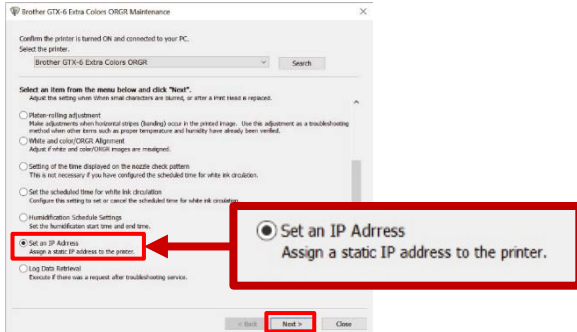

- 4) Select the setting method -> [Next].

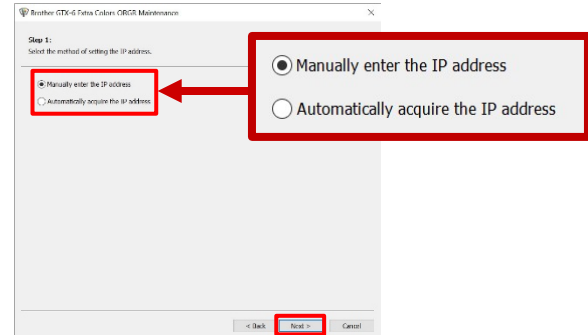

If you selected "Manually enter the IP address"

5) Enter the values of [IP Address][Subnet Mask][Default Gateway] -> [Next].

The message [IP Address has been set.] appears, and the process is complete.

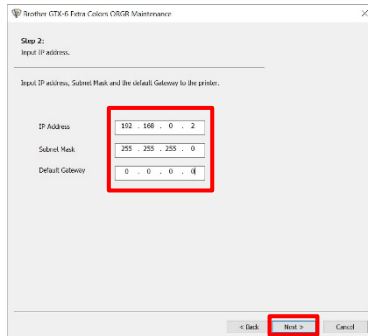

Brother GTX-6 Extra Colors ORGR Maintenance

Step 2:
Input IP address.

Input IP address, Subnet Mask and the default Gateway to the printer.

IP Address	192 . 168 . 0 . 2
Subnet Mask	255 . 255 . 255 . 0
Default Gateway	0 . 0 . 0 . 0

< Back Next > Cancel

If you selected "Automatically acquire the IP address"

5) Enter the hostname -> Click [Next].

The message [IP Address has been set.] appears, and the process is complete.

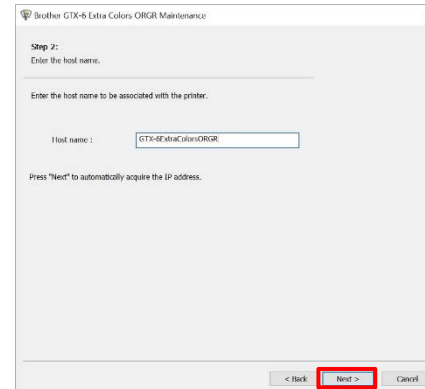

Brother GTX-6 Extra Colors ORGR Maintenance

Step 2:
Enter the host name.

Enter the host name to be associated with the printer.

Host name : GTX-6ExtraColorsORGR

Press "Next" to automatically acquire the IP address.

< Back Next > Cancel

Installing the network print driver

- 1) Connect the printer and PC to a network using LAN cables and turn the printer power ON.
- 2) Windows 10: [Settings] -> [Devices] -> [Printers & scanners] -> click [+]
Windows 11: [Settings] -> [Bluetooth & devices] -> [Printers & scanners] -> click [Add device]



- 3) Windows 10: [The printer that I want isn't listed] -> select [Add a local printer or network printer with manual settings] -> click [Next]
Windows 11: Select [Add manually] -> click [Next]

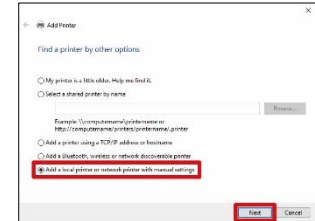
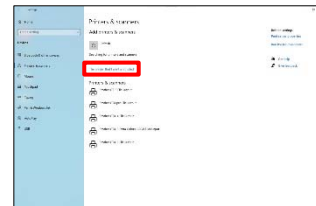

- 4) Select [Create a new port] -> From [Type of port], select [Standard TCP/IP Port] -> [Next].

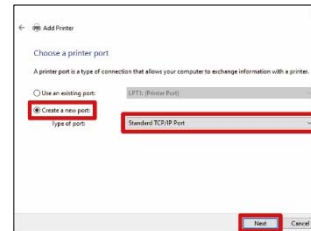

Connection to a PC

- 5) Enter the static IP address of the printer into [Type a printer hostname or IP address] -> Make sure that the check box of [Query the printer and automatically select the driver to use] is checked -> [Next].

Additional details: (Search WPS and Wi-Fi) (Cancel)

Tip: To search for WPS printers, choose values for IP from the drop-down list.

You can omit steps 6) through 8) if the printer driver to use is automatically selected. Follow the steps if it cannot be selected automatically.

If you set the printer's IP address by automatic acquisition, you must check the IP address of the printer in advance. You can confirm the IP address by selecting [Confirm network setting] -> [IP Address] from the menu. For details, refer to "7-24. Confirm network setting" in the Instruction Manual.

If you are using a DNS server, you can use a host name and domain name instead of the IP address. Enter the host name by referring to "7-24. Confirm network setting" in the Instruction Manual. As for the domain name, check with your network administrator.



TIPS

When the printer screen displays "00X", enter "X" in the IP address field.

- 6) From [Device Type], select [Custom] -> [Settings].

- 7) From [Protocol], select [LPR] -> Enter "BINARY_P1" in the [Queue Name] of [LPR Settings] -> [OK] -> [Next].



TIPS

8) From [Manufacturer], select [Brother] -> From [Printer], select [Brother GTX-6 Extra Colors ORGR] -> [Next].

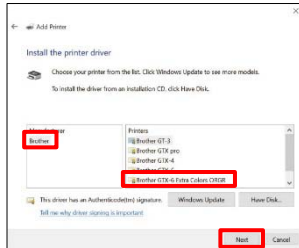

9) Select [Replace the current driver] -> [Next].

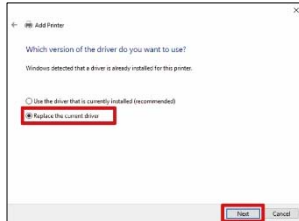

10) Enter the [Printer name] -> [Next].

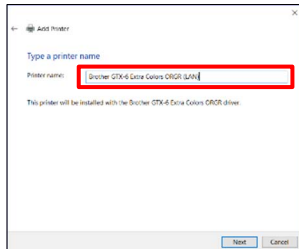

11) Select [Do not share this printer] -> [Next] -> [Finish].

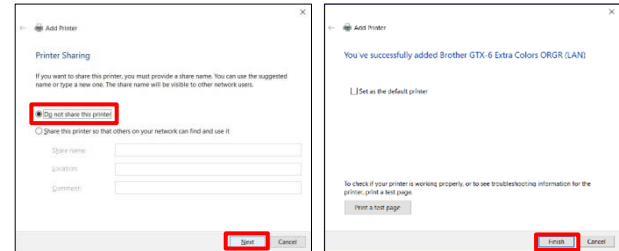

Adjustment

1 Checking the nozzle check pattern

1) Check that the print head is installed correctly.



Press two places on the top of all print heads with your finger to ensure they do not move.

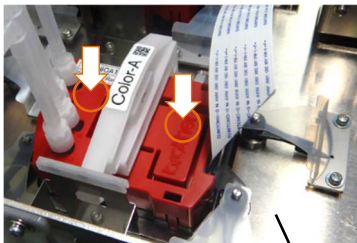

Carriage base

2) Make sure that the platen height is set at the "A" position.



Use a platen sized 14 in. x 16 in. (356 mm x 406 mm), which is included at the time of your purchase.

3) Place a sheet of A4 or letter-size white paper as illustrated below (Pretreated T-shirt is also acceptable). If the paper tends to be floated, tape the corners.

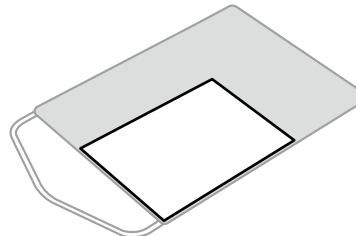

X1032

4) Perform the following operation on the screen of the printer:



-> [Test Print] -> [Nozzle Check CMYK] ->





Press and hold the two print buttons at the same time.



TIPS

You will hear a sound each time you press the print buttons and after a certain period lapses. Keep pressing them until the second sound is heard. Releasing them too soon causes the printing to be canceled.

5) When printing is finished, and the printer returns to Standby mode, set a piece of black paper or transparent sheet (such as OHP sheet) of A4 or letter size in the same manner as step 2. (A pretreated black or dark color T-shirt is also acceptable.)

- 6)  -> [Test Print] -> [Nozzle Check White] ->  ->



Press and hold the two print buttons at the same time.



TIPS

You will hear a sound each time you press the print buttons and after a certain period lapses. Keep pressing them until the second sound is heard. Releasing them too soon causes the printing to be canceled.

- 7) When printing is finished and the printer returns to Standby mode, set a piece of A4 or letter-size white paper in the same manner as in step 2 (a pretreated T-shirt is also acceptable).

- 8)  -> [Test Print] -> [Nozzle Check SP] ->  ->

->Press and hold the two print buttons at the same time.



TIPS

You will hear a sound each time you press the print buttons and after a certain period lapses. Keep pressing them until the second sound is heard. Releasing them too soon causes the printing to be canceled.

- 9) Check the printed results for both nozzle check prints and determine if there is a problem. If missing nozzles are found as indicated by the arrows below, there is a problem concerning the firing of the print heads.



TIPS

Even if the lines of the white-side printed result are light, since white ink is fired from more than one nozzle on the same place, the quality is not affected.

The following items are printed at the bottom of the nozzle check pattern:

Serial number, firmware version, print date (day/month/year), time, temperature, humidity, and number of prints

The name of the corresponding head (Head A or Head B) is printed next to each nozzle check pattern.

Adjustment

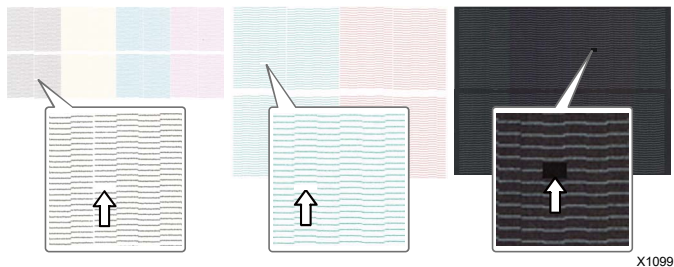

X1099

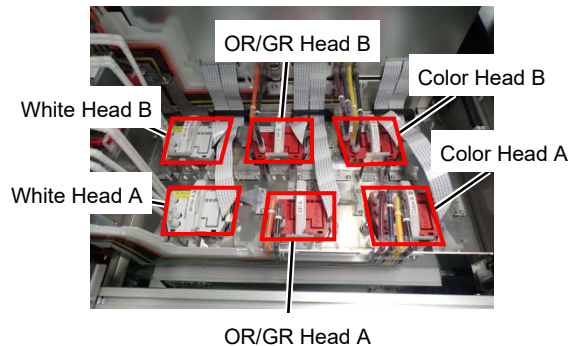

10) If any problem is found, perform a normal cleaning.

While the printer is in Standby mode, press  -> Select

the head with the problem -> Press .

11) Check the nozzle check pattern again.

If the problem still persists, please contact your dealer.

2 Making print head adjustments

- 1) Connect the printer and PC via a USB 3.0 cable or LAN cable. On the PC side, from "Brother GTX-6 Extra Colors ORGR Tools", Activate "GTX-6 Extra Colors ORGR Maintenance".
- 2) Prepare a few sheets of A4 or letter-size paper (black paper or transparent sheet such as OHP sheet and white paper), tape for fixing the paper, and a pretreated black or dark color T-shirt.



For details for pretreatment, refer to the Instruction Manual.

- 3) Make print head adjustments by following the instructions on the "GTX-6 Extra Colors ORGR Maintenance" screen.

	Menu name	Things to prepare
1	[Initial settings after head replacement]	—
2	[Color adjustments between color/ORGR heads]	White paper
3	[Firing Adjustment]	Black paper or transparent sheet (such as OHP sheet) White paper
4	[Position adjustment for the 2 heads of the same color]	Black paper or transparent sheet (such as OHP sheet) White paper
5	[Platen-Rolling Adjustment]	White paper
6	[White and Color/ORGR Alignment]	Black paper or pretreated black or dark color T-shirt
7	[Setting of the time displayed on the nozzle check pattern]	—
8	[Setting of the scheduled time for white ink circulation]	—
9	[Setting of the scheduled time for humidification]	—



Maintenance list

To maintain the printing quality and use the printer for a longer time, the following maintenance is needed.
For details, refer to the Instruction Manual.

Maintenance timing	Description	Error / Warning display
Before printing	Print out of the nozzle check pattern (checking on the print heads)	—
When an error / warning is displayed	Confirmation and disposal of waste ink	○
	Confirmation and disposal of waste water	○
	Refilling the ink	○
	Refilling the cleaning solution	○
	Cleaning the nozzle guard and suction cap	○
	Replacing the wiper, flushing foam, cap foam, and carriage foam	○
	Replacing the mist fan filter	○
When the printer becomes dirty	Head cleaning	—
	Cleaning the internal area of printer	—
	Replacing the platen sheet	—



*Please note that the contents of this manual may differ slightly from the actual product purchased as a result of product improvements.

BROTHER INDUSTRIES, LTD. <https://www.brother.com/>

1-5, Kitajizoyama, Noda-cho, Kariya 448-0803, Japan.

© 2023-2024 Brother Industries, Ltd. All Rights Reserved.

This is the original instructions.

GT60SB
SC7329-201 EN
2024.07.F(1)