

GTX600SB

PARTS BOOK

GARMENT PRINTER

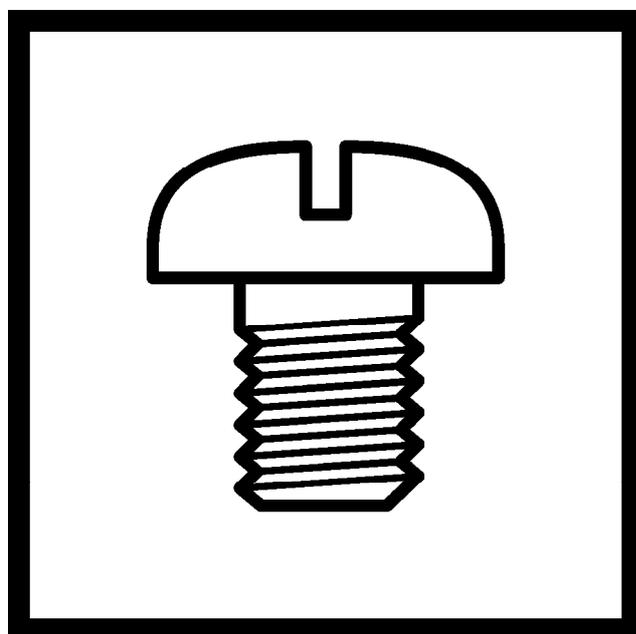

brother

The latest parts information, refer to the Parts Navigation. <http://partsbook.brother.co.jp/partsnavi/eng/>

Notes for using this parts book

1. This book was prepared based on information available in January 2023.
2. Parts are subject to changes in design without prior notice.
3. Parts supplied as complete assemblies are circled by a dotted line.
4. The part which has the symbol "+" on its number (REF.NO) in the figure differs depending on the machine model or specification. For details, refer to the parts list.

CONTENTS

A. Frame mechanism	4
B. Cover mechanism	6
C. Platen mechanism	8
D. Carriage mechanism	10
E. Maintenance mechanism	12
F1. Ink supply mechanism	14
F2. Ink supply mechanism	16
F3. Ink supply mechanism	18
G1. Control box	20
G2. Control box	22
H. Power supply equipment	24
J. Operation panel	26
K. Accessories	28
Co. Consumables & Option parts	30
Wa1. Warning labels	34
Wa2. Warning labels	35
Index	36

A. フレーム関係 / Frame mechanism

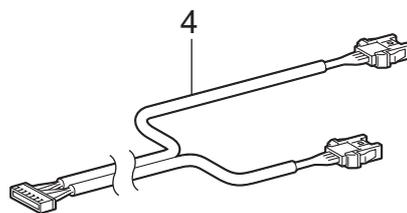
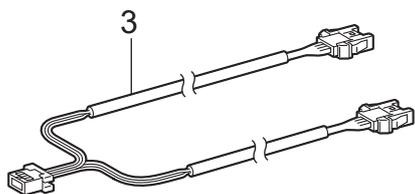
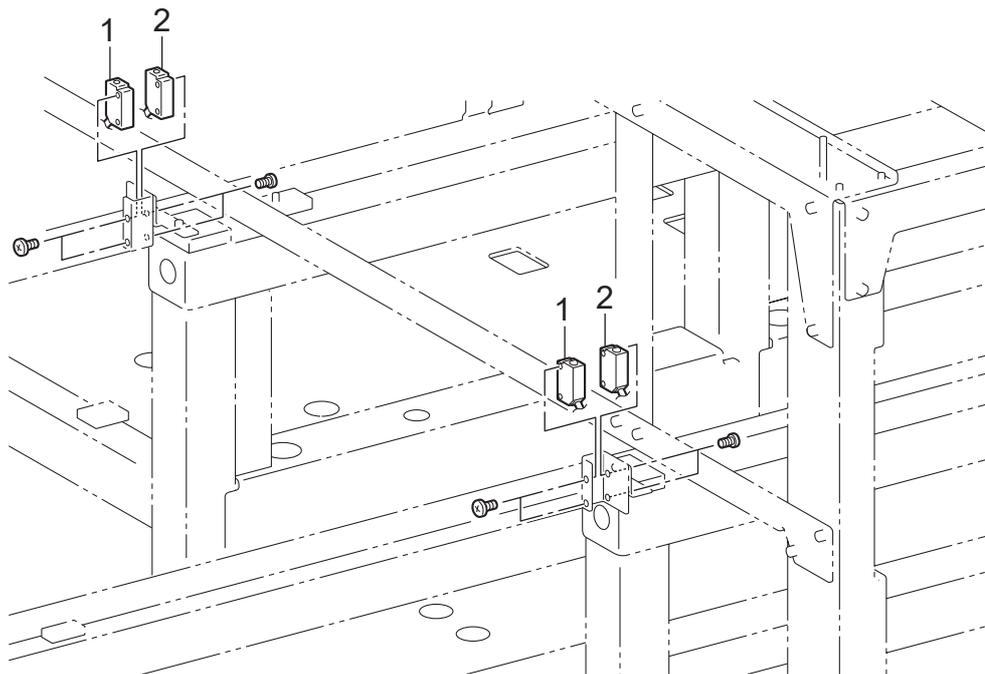

A. フレーム関係 / Frame mechanism

REF.NO	CODE	Q'TY	品名	NAME OF PARTS	RM
1	SC3125001	1	<下げすぎ検知用> コウデンスイッチ15 X6	<Platen too low sensor> PHOTOELECTRIC SWITCHES 15 X6	
2	SC3126001	1	<障害物検知用> コウデンスイッチ11 X6	<Obstcl sensorr> PHOTOELECTRIC SWITCHES 11 X6	
3	SC4230101	1	PRTSWチュウケイハーネス	HARNESS REPF-RL PRTSW	
4	SC4231101	1	PTテイシチュウケイハーネス	HARNESS REPF-RL PTSTOP	

B. カバー関係 / Cover mechanism

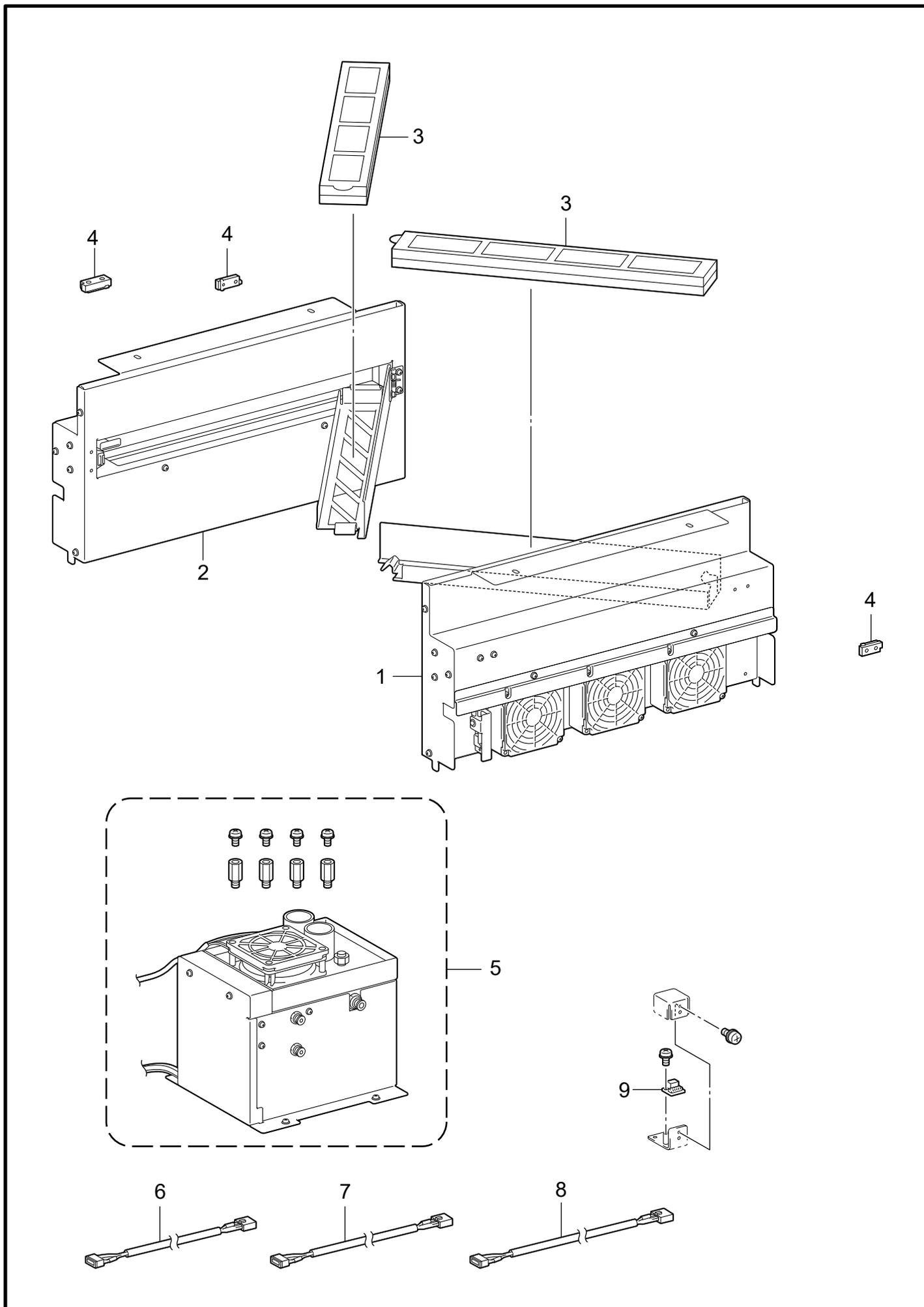

B. カバー関係 / Cover mechanism

REF.NO	CODE	QTY	品名	NAME OF PARTS	RM
1	SC5064101	1	ミストファンRホキュウクミ	MIST FAN R SUPPLY ASSY	
2	SC5065001	1	ミストファンLホキュウクミ	MIST FAN L SUPPLY ASSY	
3	SC5066001	2	ミストファンフィルターセット	MIST FAN FILTER SET	
4	SC3573001	3	キンセツセンサX6	PROXIMITY SENSOR X6	
5	SC5067201	1	カシツキホキュウクミ	HUMIDIFIER SUPPLY ASSY	
6	SC4219101	1	オンシツドセンサハーネスB	HARNESS REPF-HUM THM HUM B	
7	SC4220101	1	オンシツドセンサハーネスR	HARNESS REPF-HUM THM HUM R	
8	SC4221001	1	オンシツドセンサハーネスL	HARNESS REPL-HUM THM HUM L	
9	LM9291001	1	オンシツドセンサCHS-CSC	THM/HUM SENSOR:CHS-CSC-20	

C. プラテン関係 / Platen mechanism

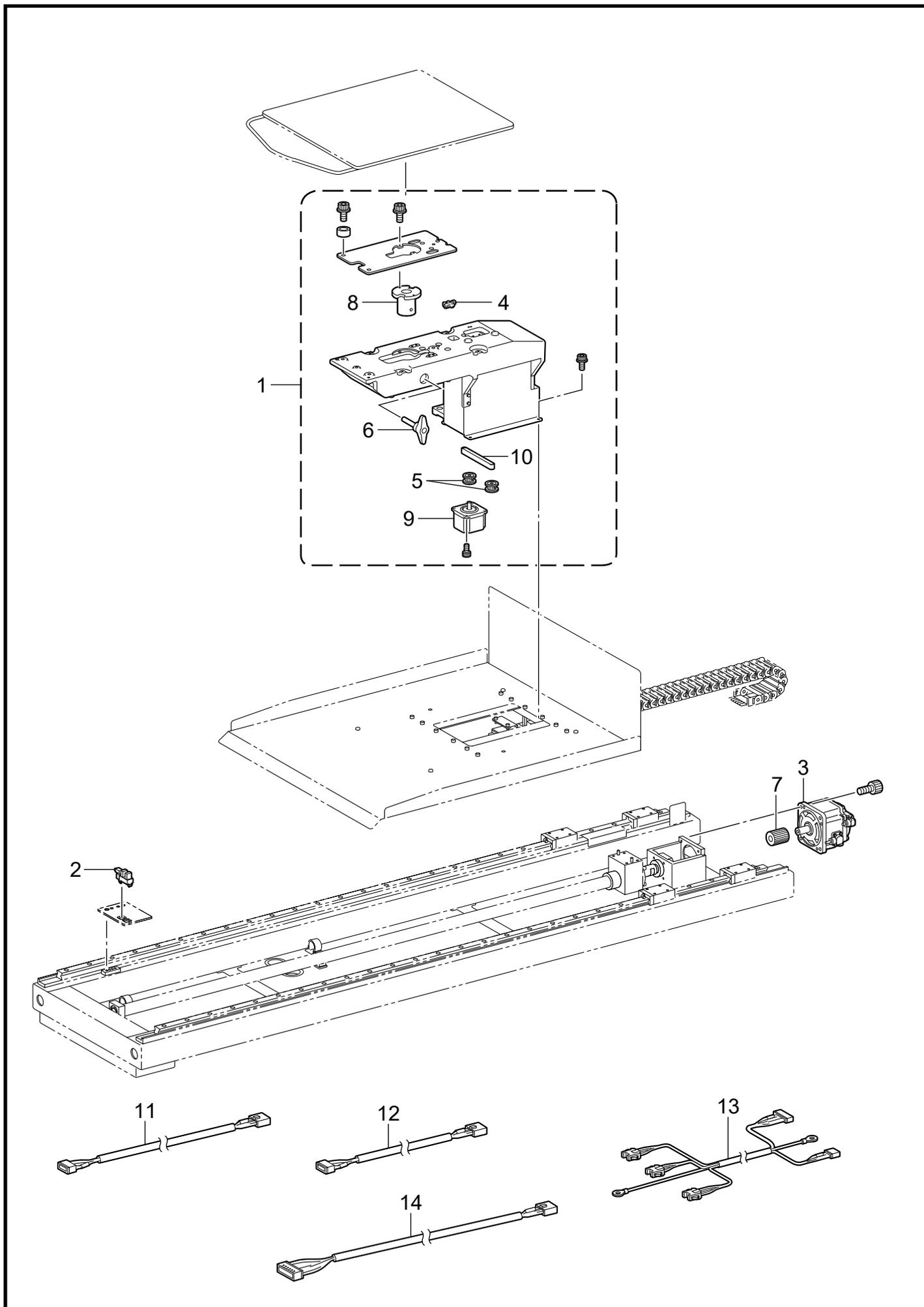

C. プラテン関係 / Platen mechanism

REF.NO	CODE	Q'TY	品名	NAME OF PARTS	RM
1	SC2499001	1	プラテンショウコウクミX6	PLATEN ELEVATOR ASSY X6	
2	LG2239001	1	PHINTSG-2482A	PHOTO INTERRUPTER:SG-2482A	
3	SC3585001	1	サーボモータプラテン	SERVO MOTOR PLATEN	
4	LG2239001	1	PHINTSG-2482A	PHOTO INTERRUPTER:SG-2482A	
5	SC2525001	2	ショウコウプーリX6	ELEVATOR PULLEY X6	
6	SC2526001	1	コテイレバ-X6	CLAMP LEVER X6	
7	SC2527001	1	プラテンカップリングX6	PLATEN COUPLING X6	
8	SC3080001	1	プラテンジクウケX6	BUSH PLATEN SHAFT X6	
9	SC3527001	1	プラテンパルスモータ	PLATEN PULSE MOTOR	
10	SC3544001	1	ショウコウベルトX6	ELEVATOR BELT X6	
11	SC4226101	1	PTオクリゲンテンハーネス	HARNESS REPL-PT ORG LF	
12	SC4227001	1	PTショウコウモータハーネス	HARNESS RBT-PT ORG LIFT	
13	SC4228101	1	PTセンサロボットハーネス	HARNESS REPL-PT SEN	
14	SC4229101	1	PTモータロボットハーネス	HARNESS REPL-PT MOT	

D. キャリッジ関係 / Carriage mechanism

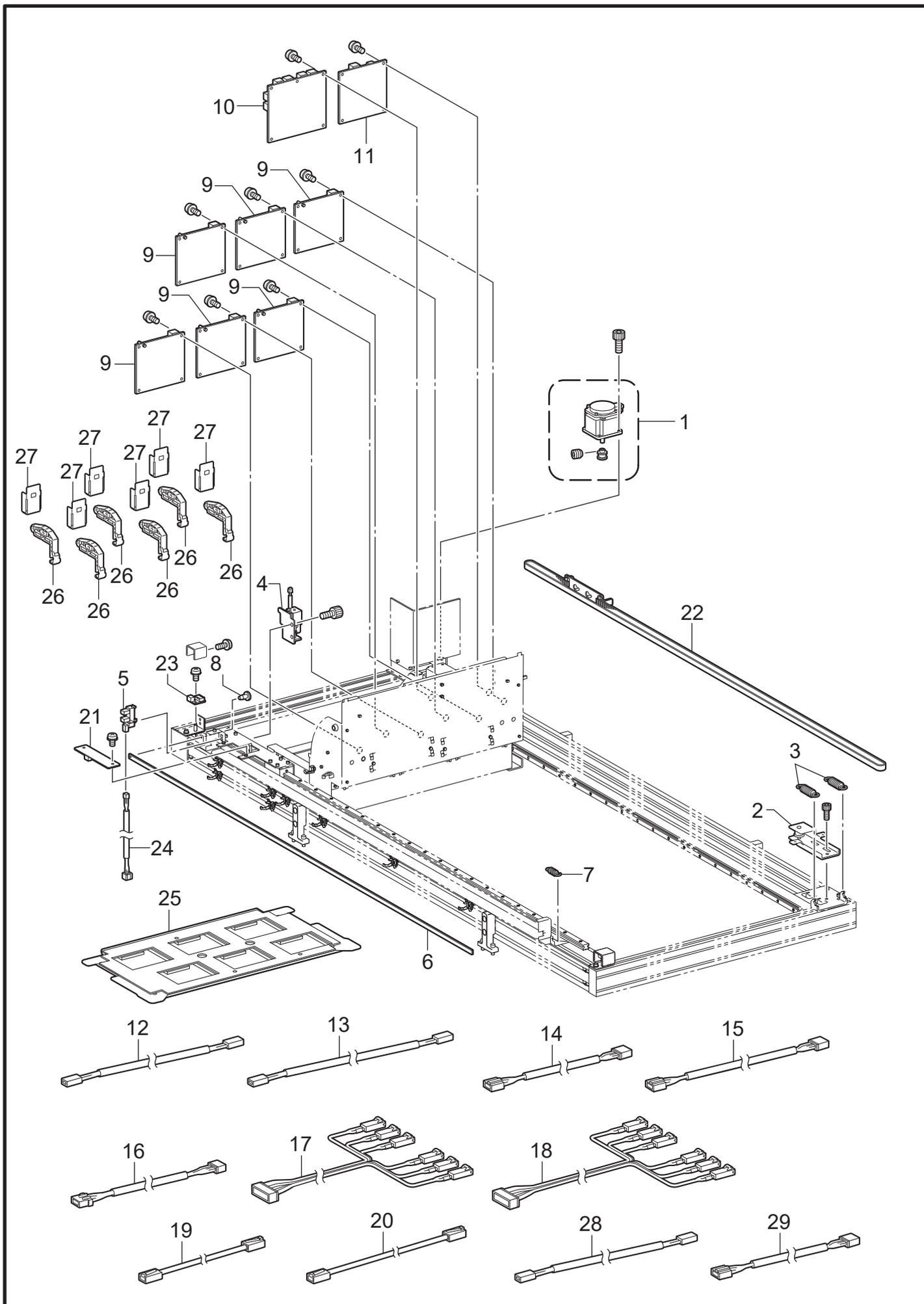

D. キャリッジ関係 / Carriage mechanism

REF.NO	CODE	Q'TY	品名	NAME OF PARTS	RM
1	SC2543001	1	キャリッジモータクミ	CARRIAGE MOTOR ASSY	
2	SC2546001	1	キャリッジアイドルクミ	CR IDLER ASSY	
3	SC2551101	2	CRアイドルバネ	CR IDLER SPRING	
4	SC2589001	1	CRロッカーソレノイド	CR LOCKER SOLENOID	
5	LG2239001	1	PHINTSG-2482A	PHOTO INTERRUPTER:SG-2482A	
6	SC2555101	1	エンコーダストリップGTX6	ENCODER STRIP GTX6	
7	S03607001	1	ボタンヒラキツメバネ	SPRING	
8	SB2017001	1	ナイロンリベット	RESIN RIVET	
9	SC3237201	6	ヘッドセイギョキバンクミ	HEAD CONTROL PCB ASSY	
10	SC3256101	1	LANハブキバンクミ	LAN HUB PCB ASSY	
11	SC3246101	1	シロジュンカンキバンクミ	WHITE CIRCULATION PCB ASSY	
12	SC4232001	2	ヘッドCデンゲンハーネス	HARNESS HUBU-HDC POWER	
13	SC4234001	2	ヘッドWデンゲンハーネス	HARNESS HUBU-HDW POWER	
14	SC4238001	2	ヘッドCエンコーダハーネス	HARNESS HUBU-HDC ENCODER	
15	SC4240001	2	ヘッドWエンコーダハーネス	HARNESS HUBU-HDW ENCODER	
16	SC4244001	1	エンコーダハーネス	HARNESS HUBU-ENC ENCODER	
17	SC4245001	1	W1ジュンカンSOLハーネス	HARNESS W-INK-SOL CIRCULATION1	
18	SC4246001	1	W2ジュンカンSOLハーネス	HARNESS W-INK-SOL CIRCULATION2	
19	SC4180001	3	LANケーブル210	HARNESS LAN 210	
20	SC4182001	4	LANケーブル420	HARNESS LAN 420	
21	SC3262001	1	エンコーダキバンクミ	ENCODER PCB ASSY	
22	SC2576001	1	CRベルトクミ	CR BELT ASSY	
23	LM9291001	2	オンシツドセンサCHS-CSC	THM/HUM SENSOR:CHS-CSC-20	
24	SC4195101	1	CRゲンテンハーネス	HARNESS REPL-CR ORG	
25	SC7418001	1	キャリッジフォームSPホキユウ	CARRIAGE FOAM SP SUPPLY ASSY	
26	SC2564001	6	ヘッドオサエクミ	HEAD CLAMP ASSY	
27	SC2567101	6	ヘッドオサエロックイタクミ	CLAMP LOCK PLATE ASSY	
28	SC4233001	2	ヘッドC2デンゲンハーネス	HARNESS HUBU-HDC2 POWER	
29	SC4239001	2	ヘッドC2エンコーダハーネス	HARNESS HUBU-HDC2 ENCODER	

E. メンテナンス関係 / Maintenance mechanism

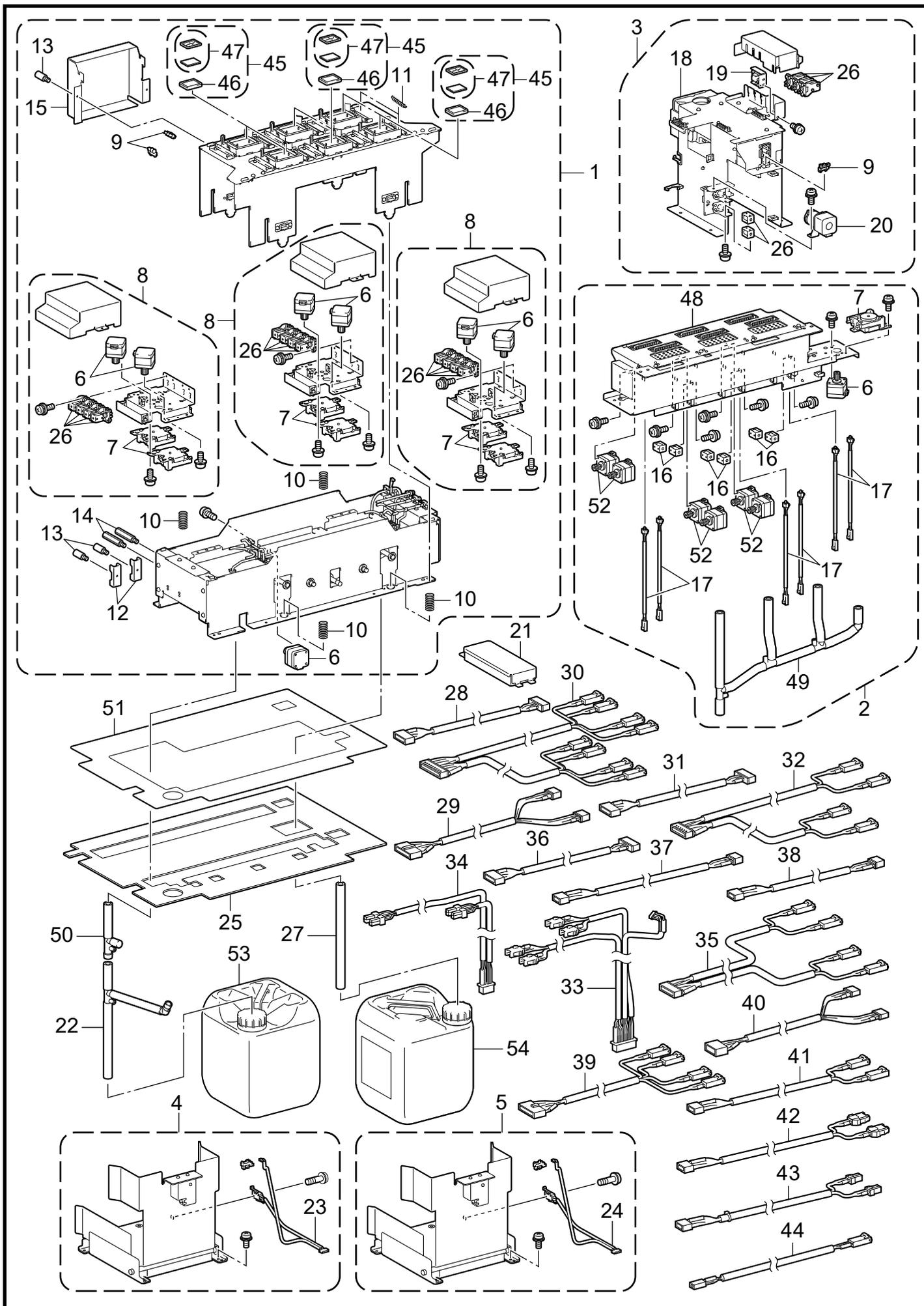

E. メンテナンス関係 / Maintenance mechanism

REF.NO	CODE	QTY	品名	NAME OF PARTS	RM
1	SC7410001	1	メンテキャップSPホキユウクミ	MAINTENANCE CAP SP SUPPLY ASSY	
2	SC7413001	1	メンテワイパSPホキユウクミ	MAINT WIPER SP SUPPLY ASSY	
3	SC7415001	1	センジョウSPホキユウクミ	WASH TANK FRAME SP SUPPLY ASSY	
4	SC7424001	1	ハイエキケンチホキユウクミ	WASTE INK DETECTION SUP ASSY	
5	SC7426001	1	ハイスイケンチホキユウクミ	WASTE WATER DETECTION SUP ASSY	
6	SC3324001	1	メンテパルスモータM0.8	MAINTENANCE PULSE MOTOR M0.8	
7	SC4907001	1	メンテポンプホキユウクミX6	MAINT PUMP SUPPLY ASSY GTX6	
8	SC4908001	1	ポンプホルダホキユウクミX6	PUMP HOLDER SUPPLY ASSY GTX6	
9	LG2239001	2	PHINTSG-2482A	PHOTO INTERRUPTER:SG-2482A	
10	SC3027001	1	メンテトッププレートバネ	MNT TOP PLATE SPRING	
11	SB6235001	1	キャップリフトバネ	CAP LIFT SPRING	
12	SC4726001	1	キャップコティイタ	CAP FIXED PLATE	
13	SC4731001	1	ツマミネジM4	THUMBSCREW M4	
14	SC0202001	1	ロツカクシチュウGTXA	HEX SUPPORT GTXA	
15	SC4713001	1	センサガイドホルダ	SENSOR GUIDE HOLDER	
16	SC7217001	1	NCソレノイド4カバーホキユウ	NC SOLENOID SH4 COVER SUP ASSY	
17	SC3715001	1	ワイプスイッチハーネスクミ	WIPE SW HARNESS ASSY	
18	SC1417001	1	タンクPホキユウクミ	TANK P SUPPLY ASSY	
19	SB9760201	1	アツリヨクセンサ10KSクミ	PRESSURE SENSOR 10KS PCB ASSY	
20	SC1647101	1	ポンプ 3F ホキユウ	PUMP 3F SUPPLY ASSY	
21	SC3815001	1	メンテハーネスカバークミ	MNT HARNESS COVER ASSY	
22	SC3818001	1	ハイエキチューブクミメンテ	WASTE INK TUBE ASSY MNT	
23	SC3726001	1	ハイエキタンクセンサハーネス	HARNESS REPL-WASTE INK TANK	
24	SC3774001	1	ハイスイタンクセンサハーネス	HARNESS REPL-WASTE WATER TANK	
25	SC4727001	1	メンテフォーム	MNT FOAM	
26	SB9937001	1	ソレノイドD3ホキユウクミ	SOLENOID D3 SUPPLY ASSY	
27	SC3591001	1	ハイエキチューブL300	WASTE INK TUBE L300	
28	SC3716001	1	メンテカムモータハーネス	HARNESS REPL-MNT CAM MOTOR	
29	SC3717101	1	メンテカムセンサハーネス	HARNESS REPL-MNT CAM SENSOR	
30	SC3693101	1	メンテポンプソレノイドハーネス	HARNESS REPL-MNT PUMP SOLENOID	
31	SC3694101	1	メンテポンプモータハーネス	HARNES REPL-MNT PUMP MOTOR	
32	SC3718101	1	メンテワイプソレノイドハーネス	HARNESS REPL-MNT WIPE SOLENOID	
33	SC3720101	1	メンテワイプモータクミハーネス	HARNESS REPL-REL WIPE	
34	SC3721001	1	メンテワイプセンサハーネス	HARNESS REPL-MNT WIPE SENSOR	
35	SC3722101	1	Sタンクソレノイドハーネス	HARNESS REPL-S TANK SOLENOID	
36	SC3723101	1	Sタンクポンプモータハーネス	HARNESS REPL-S TANK PUMP MOTOR	
37	SC3724101	1	Sタンクセンサハーネス	HARNESS REPL-S TANK SENSOR	
38	SC3725001	1	メンテアツリヨクセンサハーネス	HARNESS REPL-MNT PRES SENSOR	
39	SC5097001	1	メンテポンプSOLハーネスSP	HARNESS REPL-MNT PUMP SOL SP	
40	SC5098001	1	メンテポンプモータハーネスSP	HARNESS REPL-MNT PUMP MOTOR SP	
41	SC5099001	1	メンテワイプSOLハーネスSP	HARNESS REPL-MNT WIPE SOL SP	
42	SC5100001	1	メンテワイプMクミハーネスSP	HARNESS REPL-REL WIPE SP	
43	SC5101001	1	メンテワイプセンサハーネスSP	HARNESS REPL-MNT WIPE SEN SP	
44	SC5102001	1	SタンクソレノイドハーネスSP	HARNESS REPL-S TANK SOL SP	
45	SC7409001	6	CセットGTX6ホキユウSP	CAP SET GTX6 SUPPLY SP	
46	SC0937001	1	CラバーGTXPROホキユウ	CAP RUBBER GTXPRO SUPPLY	
47	SC7423001	6	CフォームGTXBホキユウSP	CAP FOAM GTXB SUPPLY ASSY SP	
48	SC6173001	1	シールドプレートワイパSP	SHIELD PLATE WIPER SP	
49	SC6178001	1	ハイエキチューブクミワイプSP	WASTE INK TUBE ASSY WIPE SP	
50	SC5193001	1	Cハイエキチューブクミメンテ	CAP WASTE INK TUBE ASSY MNT	
51	SC5509001	1	メンテフォームフィルム	MNT FOAM FILM	
52	SC6917001	1	メンテパルスモータM0.8DP	MAINT PLSE MOTOR M0.8 DP	
53	SC4946001	1	<廃インク用> タンク10Lホキユウクミ	<Waste Ink> TANK 10L SUPPLY ASSY	
54	SC4946001	1	<排水用> タンク10Lホキユウクミ	<Waste Water> TANK 10L SUPPLY ASSY	

F1. インク供給関係 / Ink supply mechanism

REF.NO	CODE	QTY	品名	NAME OF PARTS	RM
1	SC5080001	1	タンクシロ X6 ホキユウ	TANK WHITE X6 SUPPLY ASSY	
2	SB5346101	1	メンテパルスモータ	MAINTENANCE PULSE MOTOR	
3	LG2239001	1	PHINTSG-2482A	PHOTO INTERRUPTER:SG-2482A	
4	SB9760201	1	アツリヨクセンサ10KSクミ	PRESSURE SENSOR 10KS PCB ASSY	
5	SC3601001	1	MTモータカバー X6	MT MOTOR COVER X6	
6	SC5385001	6	タンクカラーX6ホキユウ	TANK C X6 SUPPLY ASSY	
7	SB9760201	6	アツリヨクセンサ10KSクミ	PRESSURE SENSOR 10KS PCB ASSY	
8	SC5081001	1	タンクセンジョウ X6 ホキユウ	TANK WASHING X6 SUPPLY ASSY	
9	SB9760201	1	アツリヨクセンサ10KSクミ	PRESSURE SENSOR 10KS PCB ASSY	
10	SC1646101	12	ポンプ 3 ホキユウ	PUMP 3 SUPPLY ASSY	
11	SC1647101	5	ポンプ 3F ホキユウ	PUMP 3F SUPPLY ASSY	
12	SC3188001	1	シンクウポンプクミ X6	VACUUM POMP ASSY X6	
13	SC0544001	1	シンクウポンプホルダ	VACUUM PUMP HOLDER	
14	SC3692001	1	シンクウポンプカバー X6	VACUUM PUMP COVER X6	
15	SC0433001	8	ダッキモジュールEF-AG2	DEGASSING MODULE EF-AG2	
16	SC0434001	8	ダッキモジュールオサエ	DEGASSING MODULE HOLDER	
17	SC5074001	6	NCバルブ4ホキユウクミ	NC VALVE 4 SUPPLY ASSY	
18	SC5082001	1	NCバルブ3 X6 ホキユウ	NC VALVE D3 X6 SUPPLY ASSY	
19	SC5073001	2	NOバルブ4ホキユウクミ	NO VALVE 4 SUPPLY ASSY	
20-	SC3593001	7	チューブクミ31	TUBE ASSY 31	
	Co,CS				
21	SB7680001	7	LCアクロ37ホキユウクミ	LC ACRO37 SUPPLY ASSY	
22-	SC3596001	3	チューブクミ32	TUBE ASSY 32	
	K,Y,CS				
23-M	SC3598001	1	チューブクミ33	TUBE ASSY 33	
24-C	SC3600001	1	チューブクミ34	TUBE ASSY 34	
25-W	SC3623001	2	チューブクミ44	TUBE ASSY 44	
26	SC1643001	2	フィルタAホキユウ	FILTER A SUPPLY ASSY	
27-	SC3624001	1	チューブクミ45	TUBE ASSY 45	
	W1234				
28-	SC3596001	1	チューブクミ32	TUBE ASSY 32	
	W5678				
29-W	SC3666001	2	チューブクミ65	TUBE ASSY 65	
30	SC1695001	2	Cフィルタホキユウクミ	C FILTER SUPPLY ASSY	
31-	SC3667001	1	チューブクミ66	TUBE ASSY 66	
	W1234				
32-	SC3670001	1	チューブクミ67	TUBE ASSY 67	
	W5678				
33	SC4206101	1	タンクソレノイドハーネス	HARNESS REPF-TANK SOL	
34	SC4207101	1	タンクSWハーネスWS	HARNESS REPF-TANK SW WS	
35	SC4208101	1	タンクSWハーネスCL	HARNESS REPF-TANK SW CL	
36	SC4209101	1	Wカクハンセンサハーネス	HARNESS REPF-TANK W-STIR ORG	
37	SC4210101	1	タンクPセンサハーネスWS	HARNESS REPF-TANK PSEN WS	
38	SC4211101	1	タンクPセンサハーネスCL	HARNESS REPF-TANK PSEN CL	
39	SC4212101	1	タンクFDモータハーネスW	HARNESS REPF-TANK FD MOT W	
40	SC4213101	1	タンクRNモータハーネスW	HARNESS REPF-TANK RN MOT W	
41	SC4214101	1	タンクFDモータハーネスCL	HARNESS REPF-TANK FD MOT CL	
42	SC4215101	1	タンクRNモータハーネスCL	HARNESS REPF-TANK RN MOT CL	
43	SC4216101	1	タンクFDモータハーネスS	HARNESS REPF-TANK FD MOT S	
44	SC4217101	1	Wカクハンモータハーネス	HARNESS REPF-TANK W-STIR MOT	
45	SC1680001	1	カクハンモータグラウンドワイヤ	HARNESS STIR MOTOR GROUND WIRE	
46	SC6885001	1	チューブクミ122	TUBE ASSY 122	
47	SC6886001	1	チューブクミ123	TUBE ASSY 123	
48	SC5106001	1	タンクSWハーネスSP	HARNESS REPF-TANK SW SP	
49	SC5107001	1	タンクPセンサハーネスSP	HARNESS REPF-TANK PSEN SP	
50	SC5108001	1	タンクFRモータハーネスSP	HARNESS REPF-TANK FDRN MOT SP	

F2. インク供給関係 / Ink supply mechanism

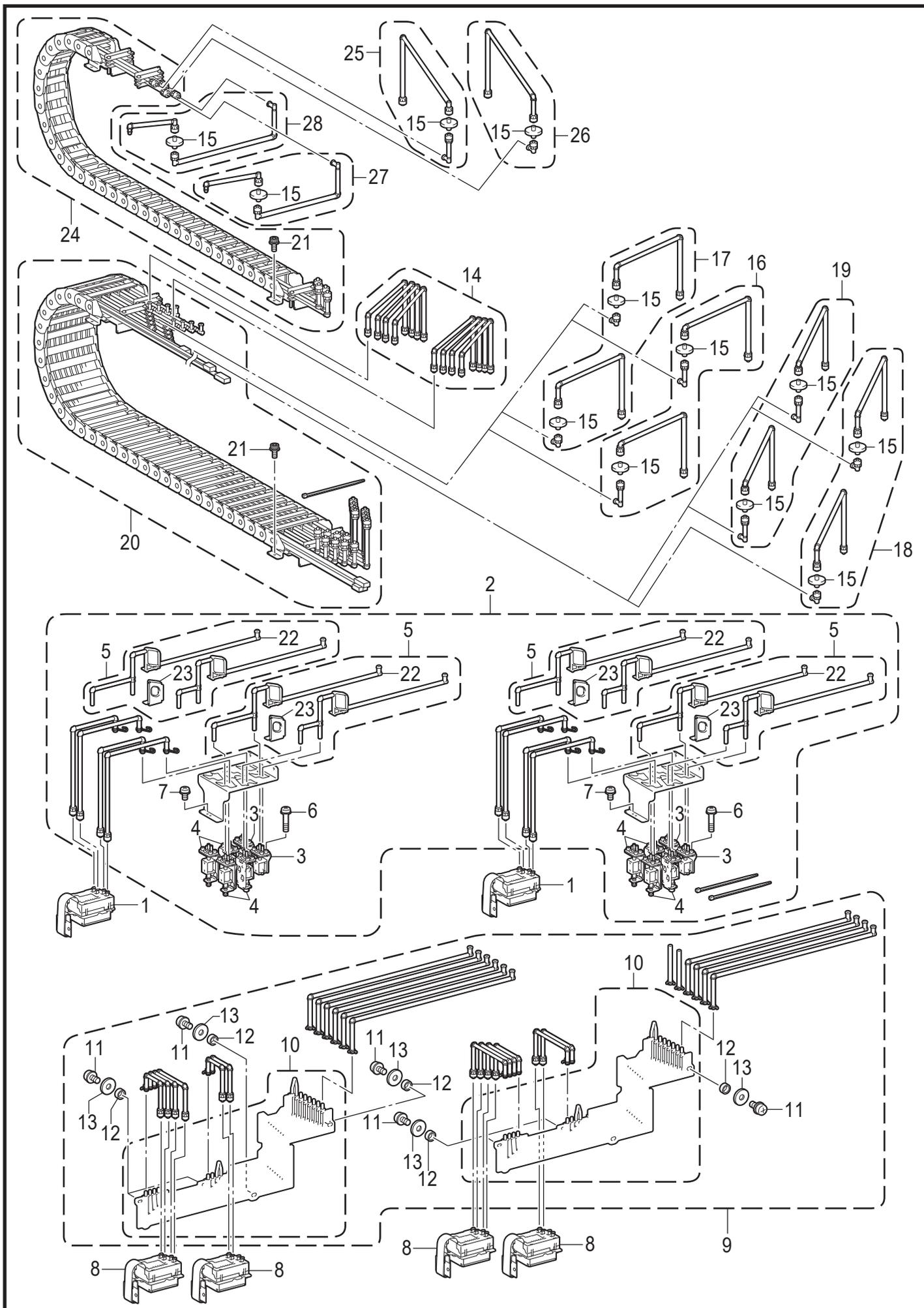

F2. インク供給関係 / Ink supply mechanism

REF.NO	CODE	Q'TY	品名	NAME OF PARTS	RM
1	SC3355001	2	ホキユウヘッドクミGTX6W	PRINT HEAD SUPPLY UNIT GTX6W	
2	SC4971001	1	Hバイパスバルブユニット	HEAD BYPASS VALVE UNIT	
3	SC5074001	4	NCバルブ4ホキユウクミ	NC SOLENOID VALVE 4 SUPPLY ASSY	
4	SC5073001	8	NOバルブ4ホキユウクミ	NO SOLENOID VALVE 4 SUPPLY ASSY	
5	SC5139001	4	Wダンパーホキユウクミ	W DAMPER SUPPLY ASSY	
6	0A5301206	24	+ナベザクミ3X12DB	SCREW PAN (S/P WASHER) M3X12	
7	SC5017001	14	+ナベザクミ3X6DB	SCREW PAN (S/P WASHER) M3X6	
8	SC3340001	4	ホキユウヘッドクミGTX6C	PRINT HEAD SUPPLY UNIT GTX6C	
9	SC7352001	1	カラーダンパーSPホキユウクミ	CL DAMPER SP SUPPLY ASSY	
10	SC5140001	2	カラーダンパーサブホキユウクミ	CL DAMPER SUB SUPPLY ASSY	
11	0A5300806	7	+ナベザクミ3X8DB	SCREW PAN (S/P WASHER) M3X8	
12	SC5129001	7	スペーサー3X2	SPACER 3X2	
13	SC5130001	7	ワッシャー10X3.2	WASHER 10X3.2	
14-W	SC5141001	1	キョウキュウチューブクミ01	SUPPLY TUBE ASSY 01	
15	SB7093001	12	LCフィルタホキユウクミ	LC FILTER SUPPLY ASSY	
16-K,C	SC5142001	1	キョウキュウチューブクミ02	SUPPLY TUBE ASSY 02	
17-Y,M	SC5156001	1	キョウキュウチューブクミ17	SUPPLY TUBE ASSY 17	
18-K,C	SC5157001	1	キョウキュウチューブクミ18	SUPPLY TUBE ASSY 18	
19-Y,M	SC5143001	1	キョウキュウチューブクミ03	SUPPLY TUBE ASSY 03	
20	SC4975101	1	チューブホルダホキユウクミ	TUBE HOLDER SUPPLY ASSY	
21	018300636	8	アナボルト3X6	BOLT SOCKET M3X6	
22	SC7210001	4	Wダンパーロングホキユウクミ	W DAMPER LONG SUPPLY ASSY	
23	SC7358001	4	WダンパーホルダX6ホキユウクミ	W DAMPER HOLDER X6 SUPPLY ASSY	
24	SC7200001	1	チューブホルダホキユウクミSP	TUBE HOLDER SUPPLY ASSY SP	
25	SC7354001	1	キョウキュウチューブクミ19	SUPPLY TUBE ASSY 19	
26	SC7355001	1	キョウキュウチューブクミ20	SUPPLY TUBE ASSY 20	
27	SC7356001	1	キョウキュウチューブクミ21	SUPPLY TUBE ASSY 21	
28	SC7357001	1	キョウキュウチューブクミ22	SUPPLY TUBE ASSY 22	

F3. インク供給関係 / Ink supply mechanism

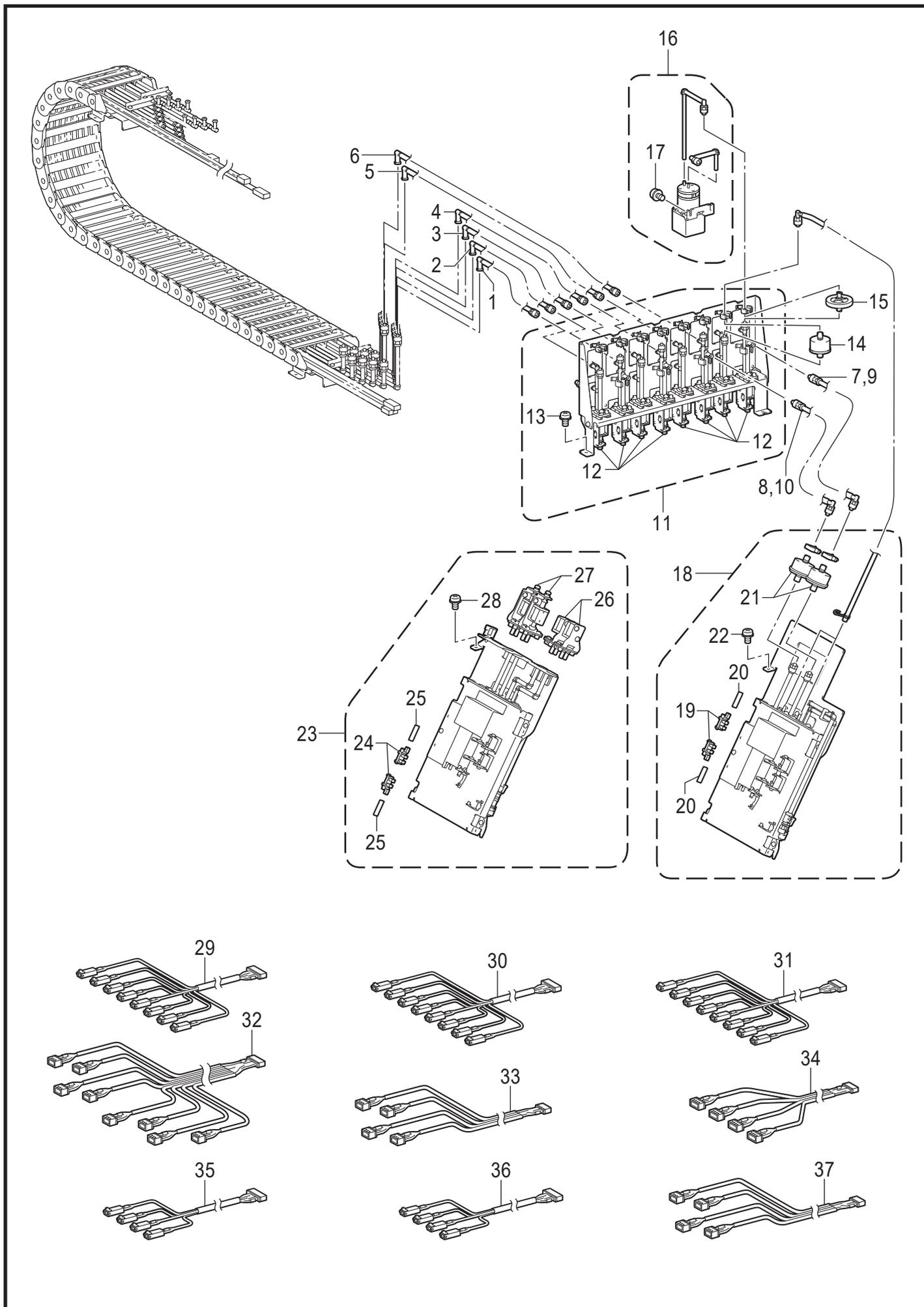

F3. インク供給関係 / Ink supply mechanism

REF.NO	CODE	Q'TY	品名	NAME OF PARTS	RM
1-W1	SC5144001	1	キョウキュウチューブクミ04	SUPPLY TUBE ASSY 04	
2-W2	SC5145001	1	キョウキュウチューブクミ05	SUPPLY TUBE ASSY 05	
3-W3	SC5146001	1	キョウキュウチューブクミ06	SUPPLY TUBE ASSY 06	
4-W4	SC5147001	1	キョウキュウチューブクミ07	SUPPLY TUBE ASSY 07	
5-W5	SC5148001	1	キョウキュウチューブクミ08	SUPPLY TUBE ASSY 08	
6-W6	SC5149001	1	キョウキュウチューブクミ09	SUPPLY TUBE ASSY 09	
7-W2	SC5152001	1	キョウキュウチューブクミ12	SUPPLY TUBE ASSY 12	
8-W4	SC5153001	1	キョウキュウチューブクミ13	SUPPLY TUBE ASSY 13	
9-W6	SC5154001	1	キョウキュウチューブクミ14	SUPPLY TUBE ASSY 14	
10-W8	SC5155001	1	キョウキュウチューブクミ15	SUPPLY TUBE ASSY 15	
11	SC4976001	1	ジュンカンバルブホキウウクミ	CIRC VALVE SUPPLY ASSY	
12	SC5073001	8	NOバルブ4ホキウウクミ	NO SOLENOID VALVE 4 SUPPLY ASSY	
13	SC5017001	4	+ナベザクミ3X8DB	SCREW PAN (S/P WASHER) M3X6	
14	SC1695001	4	Cフィルタホキウウクミ	CAPSULE FILTER	
15	SB7680001	4	LCアクロ37ホキウウクミ	LC ACRO37 SUPPLY ASSY	
16	SC5077001	4	ジュンカンポンプWホキウウクミ	CIRC PUMP W SUPPLY ASSY	
17	SC5017001	8	+ナベザクミ3X8DB	SCREW PAN (S/P WASHER) M3X6	
18	SC4977301	2	サブタンクWホキウウクミ	SUB TANK W SUPPLY ASSY	
19	LG2239001	4	PHINTSG-2482A	PHOTO INTERRUPTER:SG-2482A	
20	SB7178001	4	センサーフィルム	SENSOR FILM	
21	SC1695001	4	Cフィルタホキウウクミ	CAPSULE FILTER	
22	0A5300806	4	+ナベザクミ3X8DB	SCREW PAN (S/P WASHER) M3X8	
23	SC4979301	6	サブタンクCLホキウウクミ	SUB TANK CL SUPPLY ASSY	
24	LG2239001	12	PHINTSG-2482A	PHOTO INTERRUPTER:SG-2482A	
25	SB7178001	12	センサーフィルム	SENSOR FILM	
26	SC5074001	12	NCバルブ4ホキウウクミ	NC SOLENOID VALVE 4 SUPPLY ASSY	
27	SC5073001	12	NOバルブ4ホキウウクミ	NO SOLENOID VALVE 4 SUPPLY ASSY	
28	0A5300806	12	+ナベザクミ3X8DB	SCREW PAN (S/P WASHER) M3X8	
29	SC4198001	1	SPLYソレノイドハーネスCM	HARNESS REPR-SPLY SOL CM	
30	SC4199001	1	SPLYソレノイドハーネスKY	HARNESS REPR-SPLY SOL KY	
31	SC4200001	1	SPLYソレノイドハーネスW	HARNESS REPR-SPLY SOL W	
32	SC4201001	1	SPLYセンサハーネスCL	HARNESS REPR-SPLY SEN CL	
33	SC4202001	1	SPLYセンサハーネスW	HARNESS REPR-SPLY SEN W	
34	SC4203001	1	SPLYモータハーネス	HARNESS REPR-SPLY MOT	
35	SC5103001	1	SPLYソレノイドハーネスS1	HARNESS REPR-SPLY SOL SP1	
36	SC5104001	1	SPLYソレノイドハーネスS2	HARNESS REPR-SPLY SOL SP2	
37	SC5105001	1	SPLYセンサハーネスSP	HARNESS REPR-SPLY SEN SP	

G1. コントロールボックス関係 / Control box

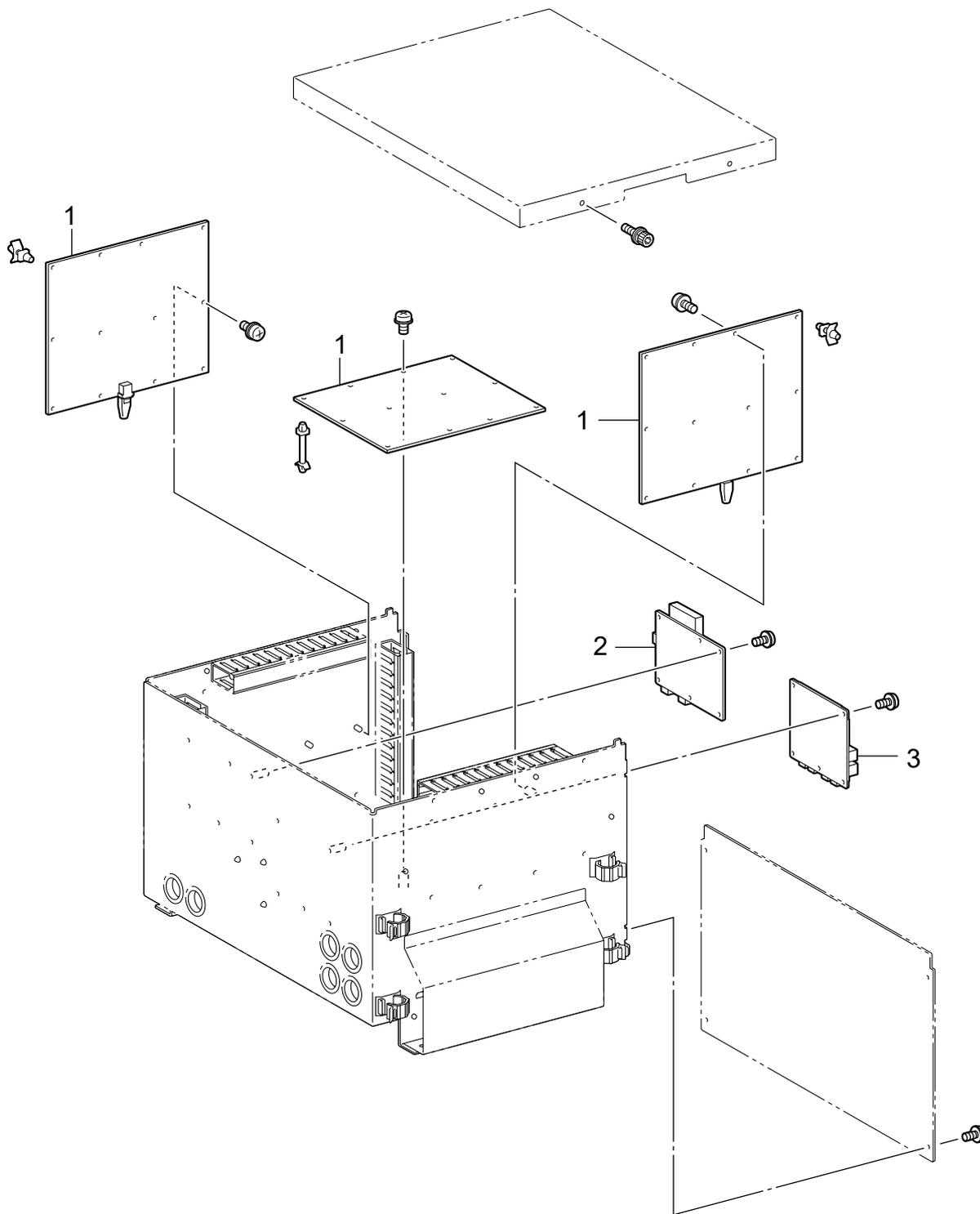

G1. コントロールボックス / Control box

REF.NO	CODE	QTY	品名	NAME OF PARTS	RM
1	SC3240101	3	アクチュエータキバンクミ	ACTUATOR PCB ASSY	
2	SC4263101	1	メインキバンホキュウクミ	MAIN PCB SUPPLY ASSY	
3	SC3256101	1	LANハブキバンクミ	LAN HUB PCB ASSY	

G2. コントロールボックス関係 / Control box

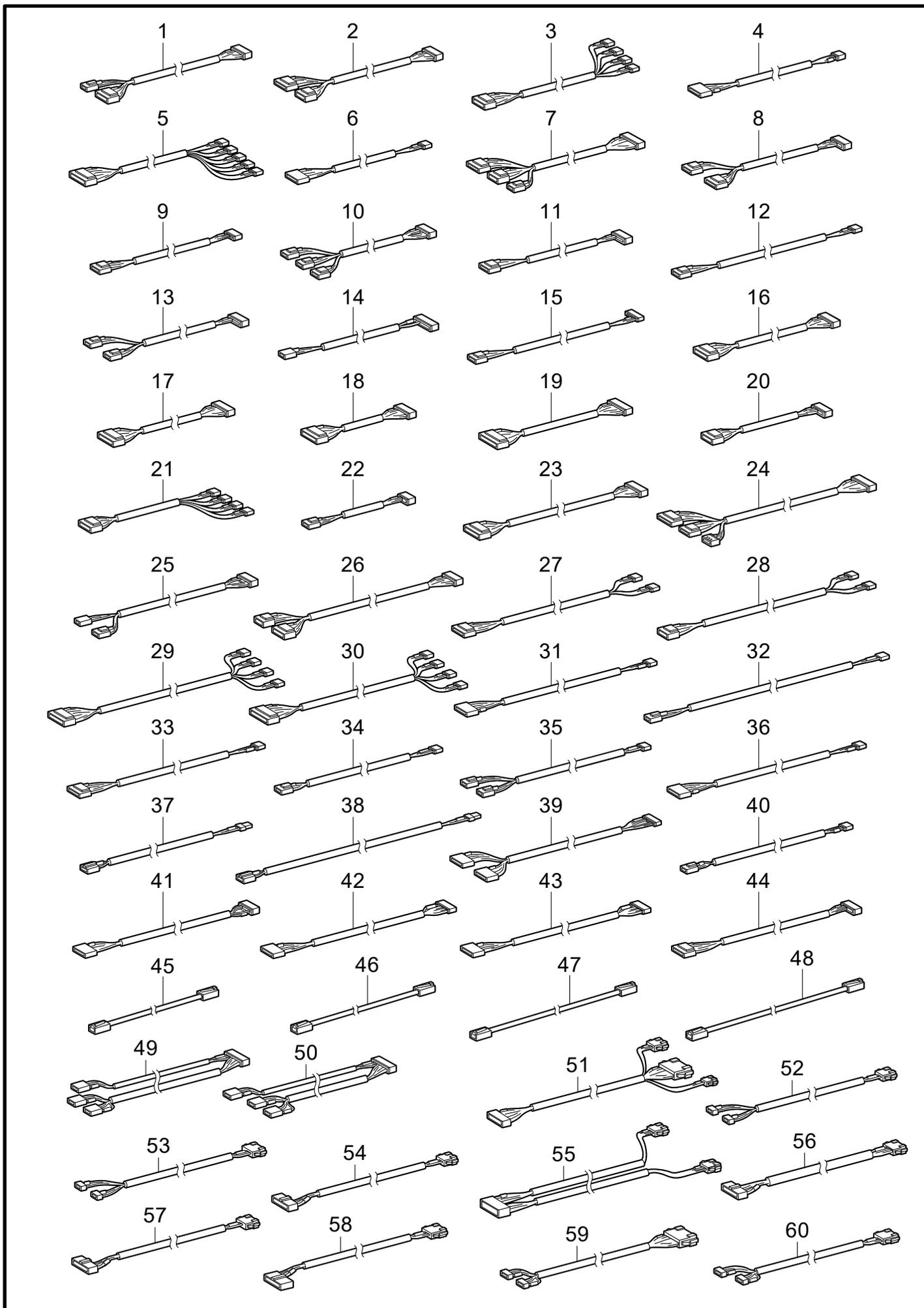

G2. コントロールボックス / Control box

REF.NO	CODE	QTY	品名	NAME OF PARTS	RM
1	SC4135101	1	メンテSOL1ハーネス	HARNESS ACTL-REPL MNT SOL1	
2	SC4136101	1	メンテSOL2ハーネス	HARNESS ACTL-REPL MNT SOL2	
3	SC4137101	1	メンテポンプモータハーネス	HARNESS ACTL-REPL MNT PUMP	
4	SC4138101	1	メンテキャップモータハーネス	HARNESS ACTL-REPL MNT CAP	
5	SC4139101	1	メンテワイブモータハーネス	HARNESS ACTL-REPL MNT WIPE	
6	SC4140101	1	メンテセンジョウモータハーネス	HARNESS ACTL-REPL MNT WASH	
7	SC4141101	1	メンテSEN1ハーネス	HARNESS ACTL-REPL MNT SEN1	
8	SC4142101	1	メンテSEN3ハーネス	HARNESS ACTL-REPL MNT SEN3	
9	SC4143101	1	メンテアツリヨクセンサハーネス	HARNESS ACTL-REPL MNT PRESS	
10	SC4144101	1	PT CRセンサハーネス	HARNESS ACTB-REPL PT CR SEN2	
11	SC4145101	1	PT24Vセンサハーネス	HARNESS ACTB-REPL PT 24V_SEN	
12	SC4146101	1	PTショウコウハーネス	HARNESS ACTB-REPL PT LIFT	
13	SC4147101	1	カバーカイヘイLセンサハーネス	HARNESS ACTL-REPL COVER SEN	
14	SC4148101	1	ミストファンLセンサハーネス	HARNESS ACTL-REPL FAN SW	
15	SC4149101	1	オンシツドセンサハーネス	HARNESS ACTL-REPL THM HUM	
16	SC4150001	1	キョウキュウKYSOLハーネス	HARNESS ACTR-REPR SPLY SOL1	
17	SC4151001	1	キョウキュウCMSOLハーネス	HARNESS ACTR-REPR SPLY SOL2	
18	SC4152101	1	キョウキュウWSOLハーネス	HARNESS ACTB-REPR SPLY SOL1	
19	SC4153001	1	キョウキュウC-SENハーネス	HARNESS ACTR-REPR SPLY SEN1	
20	SC4154001	1	キョウキュウW-SENハーネス	HARNESS ACTB-REPR SPLY SEN1	
21	SC4155001	1	Wジュンカンモータハーネス	HARNESS ACTR-REPR W CIRC	
22	SC4156101	1	カバーカイヘイRセンサハーネス	HARNESS ACTR-REPR COVER SEN	
23	SC4157101	1	サブタンクWソレノイドハーネス	HARNESS ACTB-REPF STANK SOL2	
24	SC4158101	1	タンクザンリヨウセンサハーネス	HARNESS ACTR-REPF TANK SEN3	
25	SC4159101	1	STIR FANセンサハーネス	HARNESS ACTR-REPF STR FAN SEN2	
26	SC4160101	1	タンクアツリヨクセンサハーネス	HARNESS ACTR-REPF TANK PRESS	
27	SC4161101	1	タンクWソウエキモータハーネス	HARNESS ACTB-REPF STANK WFEED	
28	SC4162101	1	タンクWハイキモータハーネス	HARNESS ACTB-REPF STANK WASTE	
29	SC4163101	1	タンクCソウエキモータハーネス	HARNESS ACTR-REPF STANK CFEEED	
30	SC4164101	1	タンクCハイキモータハーネス	HARNESS ACTR-REPF STANK WASTE	
31	SC4165101	1	タンクSソウエキモータハーネス	HARNESS ACTR-REPF TANK SFEED	
32	SC4166101	1	シンクウポンプハーネス	HARNESS ACTB-REPF VACUUM PUMP	
33	SC4167101	1	タンクカクハンモータハーネス	HARNESS ACTB-REPF TANK STIR	
34	SC4168101	1	カシツファンハーネス	HARNESS ACTR-REPF HUM FAN	
35	SC4169101	1	PTカシツSOLハーネス	HARNESS ACTR-REPF PT HUM SOL	
36	SC4170101	1	カシツポンプハーネス	HARNESS ACTB-REPF HUM PUMP	
37	SC4171201	1	カシツデンゲンハーネス	HARNESS ACTR-REPF HUM PWR	
38	SC4172201	1	カシツデンゲンハーネス	HARNESS ACTB-REPF HUM PWR	
39	SC4173101	1	オンシツドセンサハーネス	HARNESS ACTR-REPF THM-HUM SEN	
40	SC4174101	1	スピーカハーネス	HARNESS MAIN-REPF SP	
41	SC4175101	1	IC CHIPハーネス	HARNESS MAIN-REPF IC CHIP	
42	SC4176101	1	JAMセンサハーネス	HARNESS ACTB-REPF JAM SEN	
43	SC4177101	1	PTヒクスギセンサハーネス	HARNESS ACTR-REPF PT HEIGHTSEN	
44	SC4178101	1	PTテイシSWハーネス	HARNESS ACTB-REPF PT STOP SEN3	
45	SC4181001	1	LANケーブル300	HARNESS LAN 300	
46	SC4182001	1	LANケーブル420	HARNESS LAN 420	
47	SC4183001	1	LANケーブル650	HARNESS LAN 650	
48	SC4184001	1	LANケーブル800	HARNESS LAN 800	
49	SC4196101	1	ミストファンハーネスACTR	HARNESS ACTR-MIST FAN	
50	SC4197101	1	ミストファンハーネスACTL	HARNESS ACTL-MIST FAN	
51	SC5109001	1	メンテSOL3ハーネス	HARNESS ACTL-REPL MNT SOL3	
52	SC5110001	1	メンテポンプモータハーネスSP	HARNESS ACTL-REPL MNT PUMP SP	
53	SC5111001	1	メンテワイブモータハーネスSP	HARNESS ACTL-REPL MNT WIPE SP	
54	SC5112001	1	メンテSEN4ハーネス	HARNESS ACTL-REPL MNT SEN4	
55	SC5113001	1	キョウキュウSPSOLハーネス	HARNESS ACTB-REPR SPLY SOL3	
56	SC5114001	1	キョウキュウSPSENハーネス	HARNESS ACTB-REPR SPLY SEN4	
57	SC5115001	1	タンクザンリヨウセンサハーネス	HARNESS ACTR-REPF TANK SEN4	
58	SC5116001	1	タンクPセンサハーネスSP	HARNESS ACTB-REPF TANK PSEN SP	
59	SC5117001	1	タンクTソウエキモータハーネス	HARNESS ACTR-REPF STANK SPFEED	
60	SC5118001	1	タンクTハイキモータハーネス	HARNESS ACTB-REPF STANK SPRTN	

H. 電装品関係 / Power supply equipment

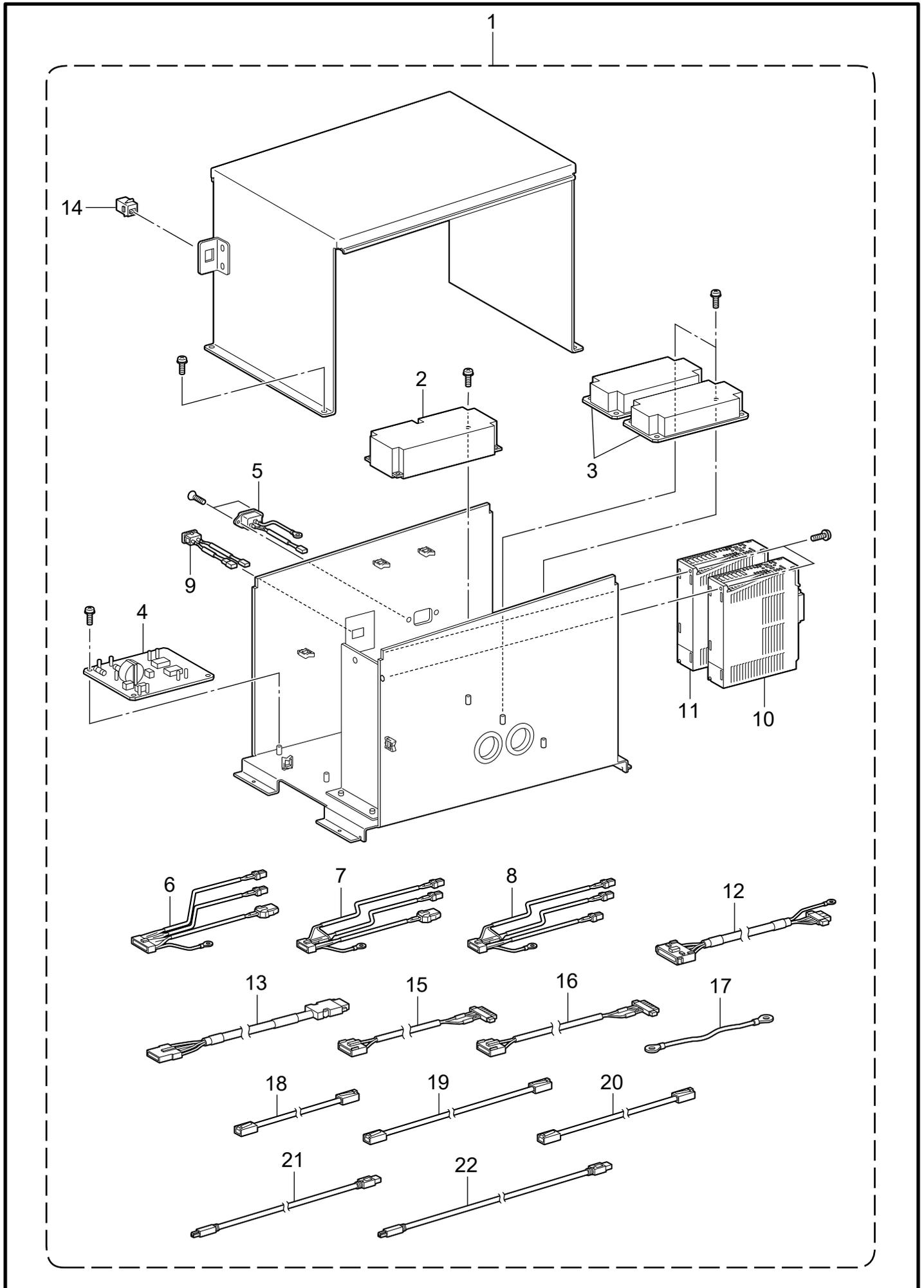

H. 電装品関係 / Power supply equipment

REF.NO	CODE	Q'TY	品名	NAME OF PARTS	RM
1	SC7212001	1	デンゲンボックスクミ	POWER SUPPLY ASSY	
2	SC3962001	1	デンゲンLHA300F-48	SW POWER SUPPLY LHA300F-48-Y	
3	SC3963001	2	デンゲンLHA150F-36	SW POWER SUPPLY LHA150F-36-Y	
4	SC7129001	1	フィルタキバンクミ	FILTER PCB ASSY	
5	SC4267001	1	ACインレットハーネスクミ	HARNESS AC INLET ASSY	
6	SC4190101	1	48Vデンゲンハーネス	HARNESS 48V DC POWER	
7	SC4191101	1	36Vデンゲンハーネス	HARNESS 36VA DC POWER	
8	SC4192101	1	36Vデンゲンハーネス	HARNESS 36VB DC POWER	
9	SC4193101	1	ACスイッチハーネス	HARNESS AC SWITCH	
10	SC4265001	1	サーボアンプPTホキユウクミ	SERVO AMP PLATEN SUPPLY ASSY	
11	SC4266001	1	サーボアンプCRホキユウクミ	SERVO AMP CARRIAGE SUPPLY ASSY	
12	SC3967001	2	サーボモータパワーハーネス	HARNESS SERVO MOTOR POWER	
13	SC3968001	2	サーボエンコーダハーネス	HARNESS SERVO ENCODER	
14	SC3866001	1	コネクタMJLSC5E	CONNECTOR: MJLSC5E-WHT	
15	SC4187101	1	アンプCデンゲンハーネス	HARNESS FILT-AMPC AC POWER	
16	SC4188101	1	アンプPデンゲンハーネス	HARNESS FILT-AMPP AC POWER	
17	SC4194101	2	アンプFGハーネス	HARNESS AMP-FG	
18	SC4180001	1	LANケーブル210	HARNESS LAN 210	
19	SC4185101	1	LANケーブル1300	HARNESS LAN 1300	
20	SC4184001	1	LANケーブル800	HARNESS LAN 800	
21	SC3971001	1	USB3.0ケーブル 2000	HARNESS USB 3.0 2000	
22	SC3970001	1	USB3.0ケーブル 3000	HARNESS USB 3.0 3000	

J. 操作パネル関係 / Operation panel

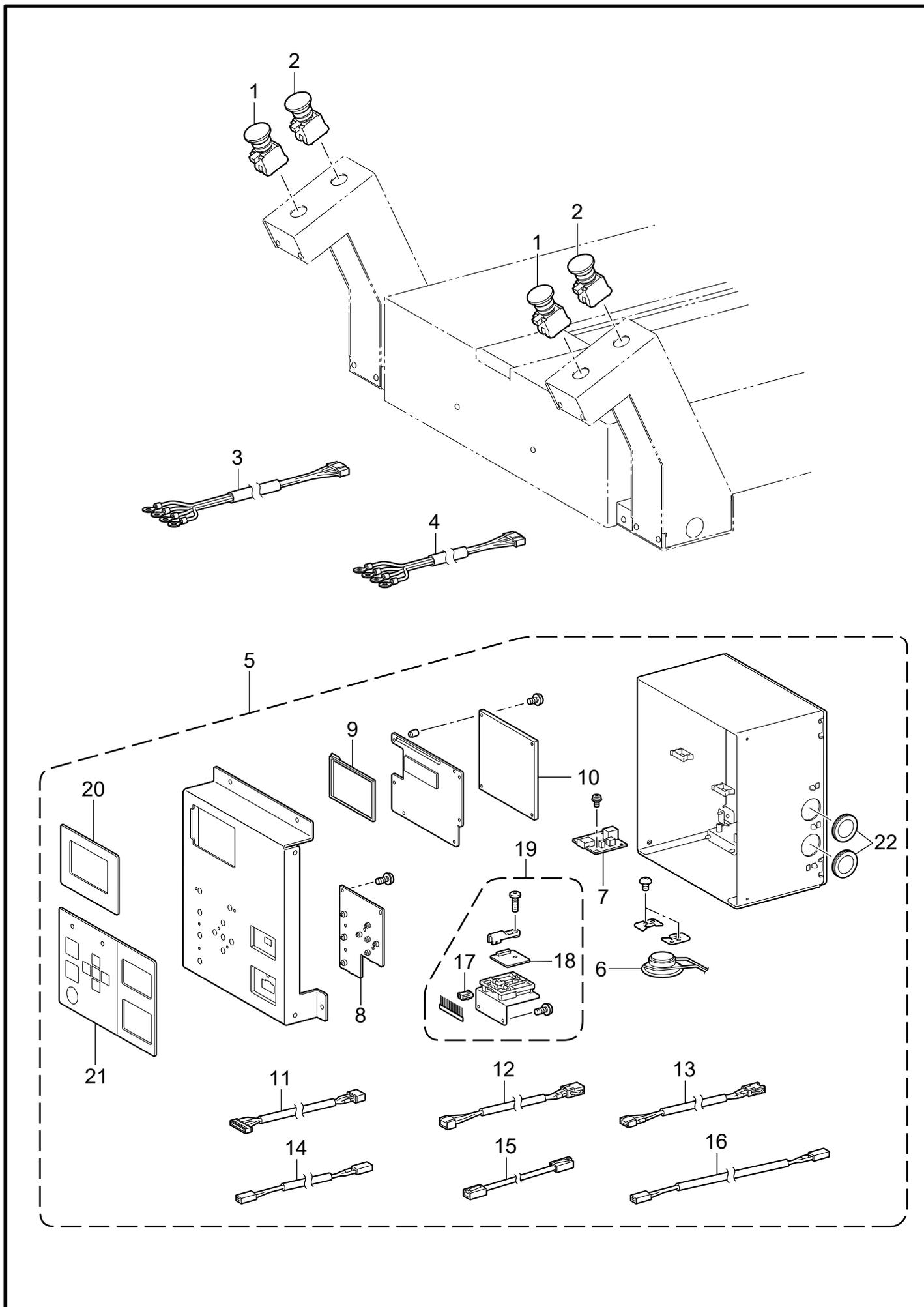

J. 操作パネル関係 / Operation panel

REF.NO	CODE	Q'TY	品名	NAME OF PARTS	RM
1	SB2400101	2	スイッチHW1L	SWITCH:HW1L-M410Q4G	
2	SC3109001	2	プラテンテイススイッチ X6	PLATEN STOP SWITCH X6	
3	SC4253001	2	プリントスイッチハーネス	HARNESS RL-PRTSW	
4	SC4254001	2	プラテンテイススイッチハーネス	HARNESS RL-PTSTOP SW	
5	SC5137201	1	パネルユニットホキユウクミ	PANEL UNIT SUPPLY ASSY	
6	SB2399001	1	スピーカユニット	SPEAKER UNIT	
7	SC3268001	1	USBチュウケイキバンクミ	USB RELAY PCB ASSY	
8	SB4746001	1	パネルキバンクミ	PANEL PCB ASSY	
9	D00N32001	1	TFT2P2893-V2	LCD:TFT2P2893-V2-E	
10	SC3259101	1	パネルセイギョキバンクミ	PANEL CONTROL PCB ASSY	
11	SC3271101	1	チップリーダーハーネス	HARNESS REPF-CHIP CHIP	
12	SC3272101	1	プリントスイッチハーネス	HARNESS PNL-REPF PRTSW	
13	SC3273101	1	サンショクトウハーネス	HARNESS PNL-REPF 3LED	
14	SC3274101	1	スピーカハーネス	HARNESS REPF-USB SPEAKER	
15	SC4186001	1	LANケーブル2850	HARNESS LAN 2850	
16	SC4250101	1	パネルデンゲンハーネス	HARNESS HUBD-PNL POWER	
17	A60014001	1	IJB-3S-1K300	CONNECTOR:IJB-3S-1K300	
18	SC4258001	1	チップヨミトリキバンクミ	CHIP READER PCB ASSY	
19	SC3445001	1	ICホルダクミX6	IC HOLDER ASSY X6	
20	SC3457101	1	LCDパネルシート	LCD PANEL SHEET	
21	SC3545001	1	パネルシートX6	PANEL SHEET X6	
22	SC3548001	2	パネルグロメットX6	PANEL GROMMET X6	

K. 付属品関係 / Accessories

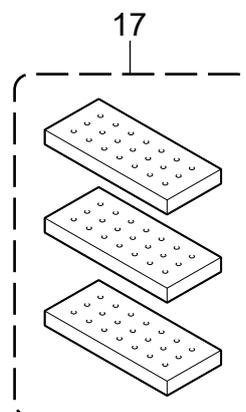
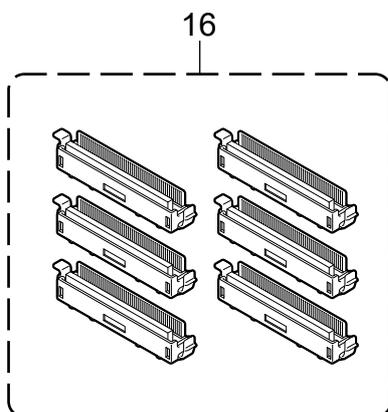
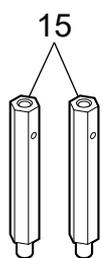
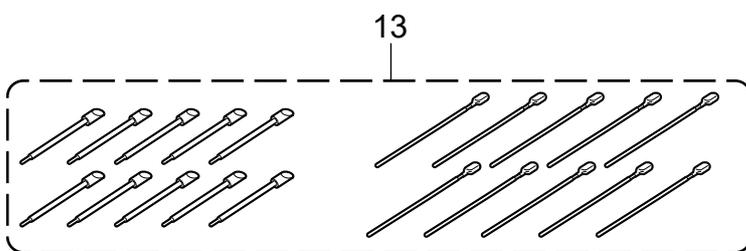
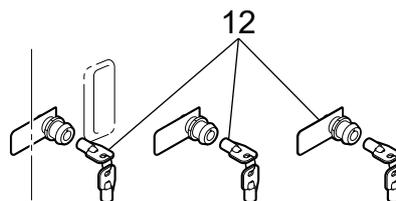
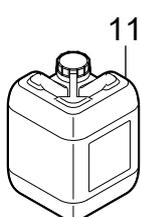
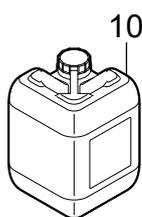
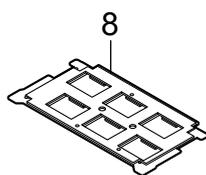
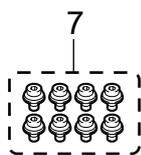
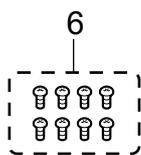
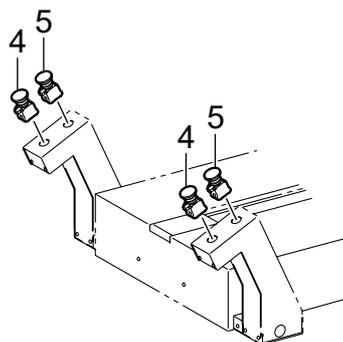
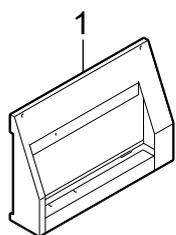

K. 付属品関係 / Accessories

REF.NO	CODE	Q'TY	品名	NAME OF PARTS	RM
1	SC3202001	1	メインタンクカバー	MAIN TANK COVER X6	
			<メインタンクカバー固定用>	<MAIN TANK COVER>	
2	SB4606001	2	+ナベザクミ4X10DB	SCREW PAN (S/P WASHER) M4X10	
3	SC4591001	2	アナキャップクロ	HOLE CAP BK	
4	SB2400101	2	スイッチHW1L	SWITCH:HW1L-M410Q4G	
5	SC3109001	2	プラテンテイシスイッチ X6	PLATEN STOP SWITCH X6	
			<スイッチカバー固定用>	<Switch Cover>	
6	008400807	8	+トラスコ4X8	SCREW TRUSS M4X8	
			<スイッチフレーム固定用>	<Switch Frame>	
7	S55479001	8	アナボルトザクミ4X8	BOLT SOCKET (S/P WASHER) M4X8	
8	SC7418001	1	キャリッジフォームSPホキユウ	CARRIAGE FOAM SP SUPPLY ASSY	
9	SC5514001	1	カシツキ パイプR	HUMIDIFIER PIPE R	
			<廃インク用>	<Waste Ink>	
10	SC4946001	1	タンク10Lホキユウクミ	TANK 10L SUPPLY ASSY	
			<排水用>	<Waste Water>	
11	SC4946001	1	タンク10Lホキユウクミ	TANK 10L SUPPLY ASSY	
12	SC4549001	3	カバーカギ X6 ホキユウクミ	COVER KEY X6 SUPPLY ASSY	
13	SC4945001	1	クリーンスティックセット X6	CLEAN STICK X6	
14	SB6925001	1	センジョウカップ	CLEANING CUP	
15	SC0202001	2	ロツカクシチュウGTXA	HEX SUPPORT GTXA	
16	SC7420001	1	ワイパホキユウクミGTX6SP	WIPER HOLDER SUPPLY GTX6 SP	
17	SC7419001	1	FフォームセットGTX6SP	FLUSHING FOAM SET GTX6 SP	

Co. 消耗品とオプション部品 / Consumables & Option parts

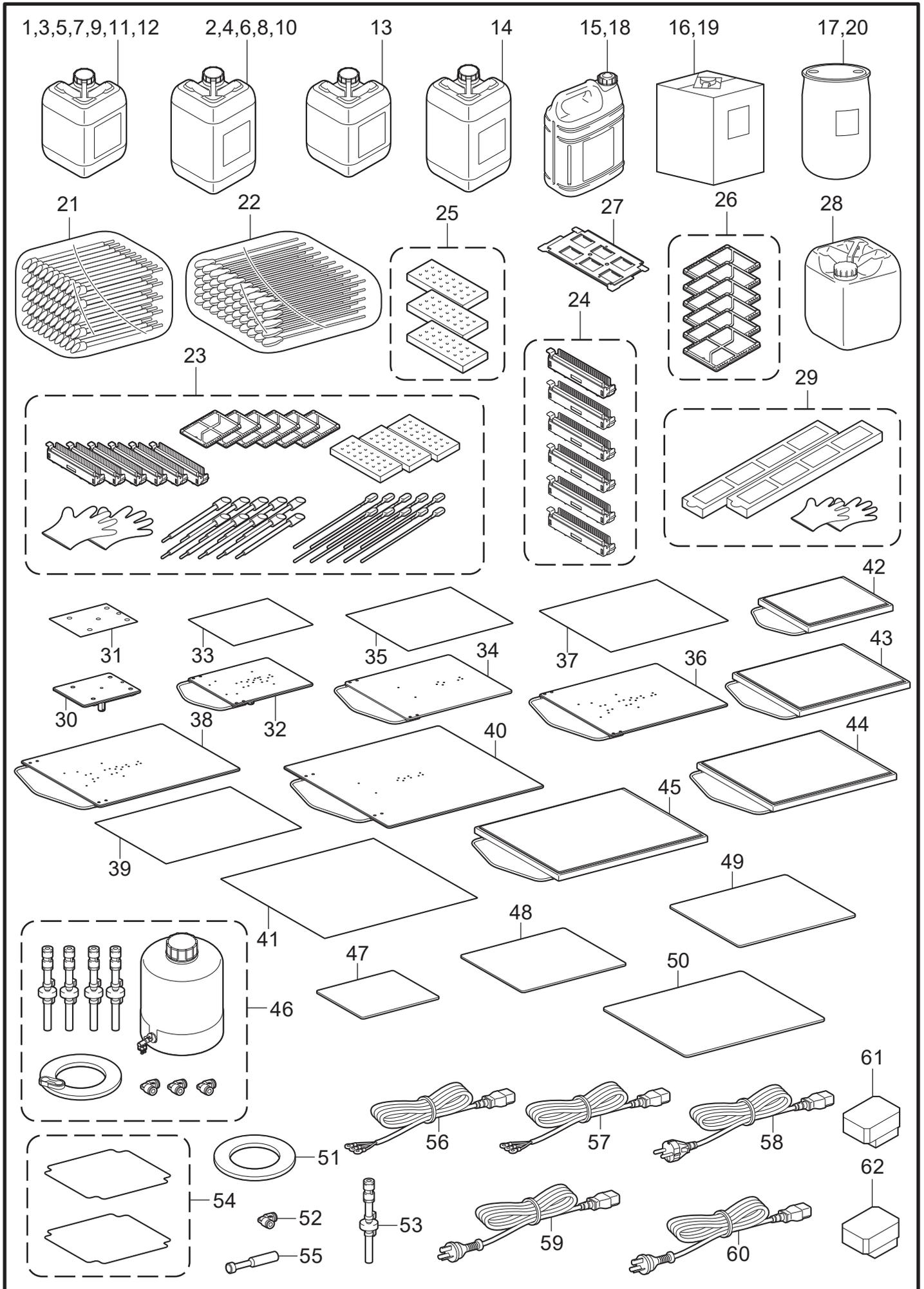

Co. 消耗品とオプション部品 / Consumables & Option parts

REF.NO	CODE	QTY	品名	NAME OF PARTS	RM
1	GCX-6K09L-1	1	ブラックインクボトル(9L)	BLACK INK BOTTLE (9L)	
2	GCX-6K18L-1	1	ブラックインクボトル(18L)	BLACK INK BOTTLE (18L)	
3	GCX-6M09L-1	1	マゼンタインクボトル(9L)	MAGENTA INK BOTTLE (9L)	
4	GCX-6M18L-1	1	マゼンタインクボトル(18L)	MAGENTA INK BOTTLE (18L)	
5	GCX-6C09L-1	1	シアンインクボトル(9L)	CYAN INK BOTTLE (9L)	
6	GCX-6C18L-1	1	シアンインクボトル(18L)	CYAN INK BOTTLE (18L)	
7	GCX-6Y09L-1	1	イエローインクボトル(9L)	YELLOW INK BOTTLE (9L)	
8	GCX-6Y18L-1	1	イエローインクボトル(18L)	YELLOW INK BOTTLE (18L)	
9	GCX-6W09L	1	白インクボトル(9L)	WHITE INK BOTTLE (9L)	
10	GCX-6W18L	1	白インクボトル(18L)	WHITE INK BOTTLE (18L)	
11	GC60OR09L	1	オレンジインクボトル(9L)	ORANGE INK BOTTLE (9L)	
12	GC60GR09L	1	グリーンインクボトル(9L)	GREEN INK BOTTLE(9L)	
13	GCX-6E09L	1	洗浄液(9L)	CLEANING SOLUTION (9L)	
14	GCX-6E18L	1	洗浄液(18L)	CLEANING SOLUTION (18L)	
15	GCX-4P05	1	前処理剤(5kg)	PRETREATMENT (5kg)	
16	GCX-4P20	1	前処理剤(20kg)	PRETREATMENT (20kg)	
17	GCX-4P2H	1	前処理剤(200kg)	PRETREATMENT (200kg)	
18	GCX-4PS05	1	<アメリカ向け> 前処理剤(5kg)	<US only> PRETREATMENT (5kg)	
19	GCX-4PS20	1	前処理剤(20kg)	PRETREATMENT (20kg)	
20	GCX-4PS2H	1	前処理剤(200kg)	PRETREATMENT (200kg)	
21	SB7008001	1	クリーンスティックR 50	CLEAN STICK R 50	
22	SC0032001	1	クリーンスティックT 50	CLEAN STICK T 50	
23	SC7421001	1	メンテナンスキットASP	MAINTENANCE KIT A SP	
24	SC7420001	1	ワイパホキュウクミGTX6SP	WIPER HOLDER SUPPLY GTX6 SP	
25	SC7419001	1	FフォームセットGTX6SP	FLUSHING FOAM SET GTX6 SP	
26	SC7423001	1	CフォームGTXBホキュウSP	CAP FOAM GTXB SUPPLY ASSY SP	
27	SC7418001	1	キャリッジフォームSPホキュウ	CARRIAGE FOAM SP SUPPLY ASSY	
28	SC4946001	1	タンク10Lホキュウクミ	TANK 10L SUPPLY ASSY	
29	SC5066001	1	ミストファンフィルターセット	MIST FAN FILTER SET	
30	SB7001201	1	ベビープラテンX (7X8)	BABY PLATEN X (7X8)	
31	SB7002101	1	プラテンシート7X8	PLATEN SHEET 7X8	
32	SC4870101	1	プラテンSクミ X6 (10X12)	PLATEN S X6 ASSY (10X12)	
33	SC3058001	1	プラテンシート10X12	PLATEN SHEET 10X12	
34	SC4871101	1	<本体同梱> プラテンMクミ X6 (14X16)	<Bundled Item> PLATEN M X6 ASSY (14X16)	
35	SC4577001	1	プラテンシート14X16 X6	PLATEN SHEET 14X16 X6	
36	SC4872101	1	プラテンLクミ X6 (16X18)	PLATEN L X6 ASSY (16X18)	
37	SC3060001	1	プラテンシート16X18	PLATEN SHEET 16X18	
38	SC4873101	1	プラテンXLクミ X6 (18X22)	PLATEN XL X6 ASSY (18X22)	
39	SC3451101	1	プラテンシート18X22	PLATEN SHEET 18X22	
40	SC4874001	1	プラテンXXLクミ X6 (24X24)	PLATEN XXL X6 ASSY (24X24)	
41	SC3542001	1	プラテンシート24X24	PLATEN SHEET 24X24	
42	SC6136101	1	プラテンSクミ X6F	PLATEN S X6F ASSY	
43	SC6137101	1	プラテンMクミ X6F	PLATEN M X6F ASSY	
44	SC6138101	1	プラテンLクミ X6F	PLATEN L X6F ASSY	
45	SC6139101	1	プラテンXLクミ X6F	PLATEN XL X6F ASSY	
46	SC5068101	1	ウォータータンクホキュウクミ	WATER TANK SUPPLY ASSY	
47	SC6156001	1	プラテンシートB10X12X6	PLATEN SHEET BRUSH 10X12 X6	
48	SC6157001	1	プラテンシートB14X16X6	PLATEN SHEET BRUSH 14X16 X6	
49	SC6158001	1	プラテンシートB16X18X6	PLATEN SHEET BRUSH 16X18 X6	
50	SC6159001	1	プラテンシートB18X22X6	PLATEN SHEET BRUSH 18X22 X6	
51	SC5070001	1	ウォーターT6040 15M	WATER TUBE 6040 15M	

Co. 消耗品とオプション部品 / Consumables & Option parts

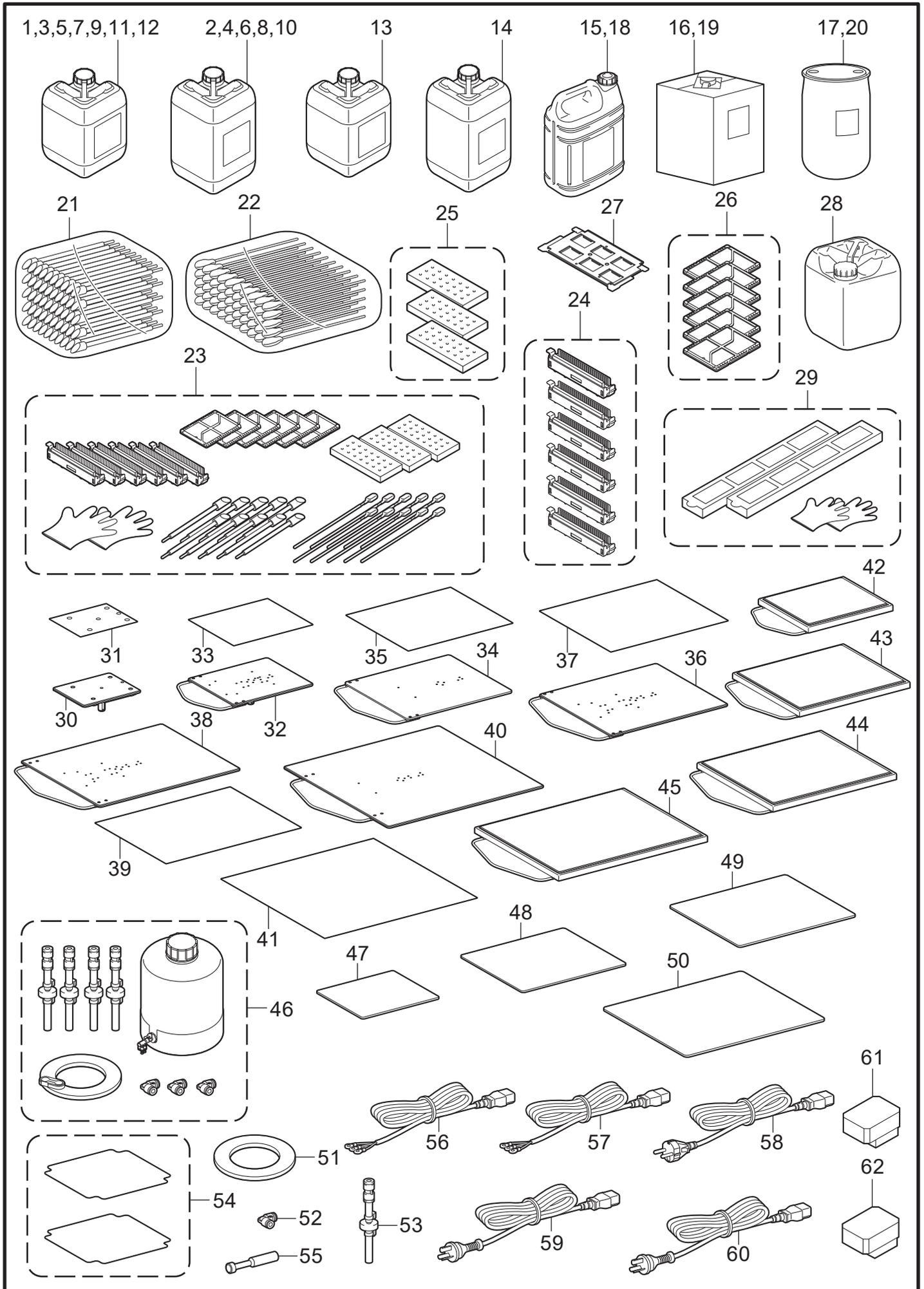

Co. 消耗品とオプション部品 / Consumables & Option parts

REF.NO	CODE	QTY	品名	NAME OF PARTS	RM
52	SC5071001	1	Lフィッティング 06-06	L FITTING 06-06	
53	SC2674001	1	カシツキフィルタクミ	HUMIDIFIER FILTER ASSY	
54	SC5138201	1	カシツキFフィルタホキユウクミ	HUMIDIFIER FAN FILTER S ASSY	
55	SC3788001	1	プラグD6	PLUG D6	
56	SC6043001	1	ACコードPSE	AC CORD PSE SUPPLY ASSY	
57	SC6044001	1	ACコードUL/CSA	AC CORD UL/CSA SUPPLY ASSY	
58	SC6045001	1	ACコードEUR	AC CORD EUR SUPPLY ASSY	
59	SC6047001	1	ACコードチャイナ	AC CORD CHINA SUPPLY ASSY	
60	SC6046001	1	ACコードAU	AC CORD AU SUPPLY ASSY	
61	SC3340001	1	<カラー、OR/GR用> ホキユウヘッドクミGTX6C	<For Color, OR/GR> PRINT HEAD SUPPLY UNIT GTX6 C	
62	SC3355001	1	<白用> ホキユウヘッドクミGTX6W	<For White> PRINT HEAD SUPPLY UNIT GTX6 W	

Wa1. 警告ラベル / Warning labels

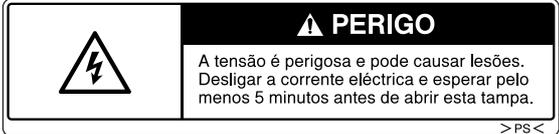
警告ラベル / Warning labels	品名 / Name of parts	Size(mm)	Code
 <p>⚠ CAUTION Moving platen, T-shirt tray and covers can cause bodily injury. Keep body parts away from moving parts.</p> <p>⚠ VORSICHT Druckplatte, T-Shirt-Ablage und Abdeckungen können körperliche Verletzungen verursachen. Halten Sie Körperteile von beweglichen Teilen fern.</p> <p>⚠ ATTENTION Déplacement du plateau, chargeur T-shirt et couvercle peut blesser le corps. Gardez les parties du corps éloignées des pièces mobiles.</p> <p>⚠ ATENCIÓN Moviendo la placa, la bandeja de camisetas y las cubiertas pueden causar una herida personal. Mantenga las partes del cuerpo alejadas de las partes móviles.</p> <p>⚠ ATTENZIONE Tavoletta mobile, il ripiano per la T-shirt ed il carter potrebbero causare infortuni. Tenere le parti del corpo lontane dalle parti in movimento.</p> <p>⚠ 注意 プラテンやTシャツトレイと各カバーとの間に手をはさみ、けがをする。運動部分から体を離すこと。</p> <p>⚠ 注意 手夾在压板、T恤托盘和各罩盖之间会导致受伤。身体切勿靠近正在运行的机器部位。</p> <p>⚠ CUIDADO Movimiento do cilindro, prato de impressão e tampas podem causar lesões corporais.</p>	<p>ラベルプラテンチュウイ LABEL PLATEN INJURY</p>	<p>115 X 160</p>	<p>SC4730-101</p>
 <p>L=50</p>	<p>ラベルケガ LABEL INJURY</p>	<p>L=50</p>	<p>SC0041-002</p>
 <p>⚠ 危険 ⚠ 危険 高電圧部分にふれて、大けがをすることがある。電源を切り、5分たってからカバーを開けず。</p> <p>⚠ DANGER ⚠ GEFAHR ⚠ DANGER ⚠ PERIGRO Hazardous voltage will cause injury. Turn off main switch and wait 5 minutes before opening this cover. Hochspannung verletzungsgefahr! Un voltage non adapté provoque des blessures. Eteindre l'interrupteur et attendre 5 minutes avant d'ouvrir le capot. Un voltaje inadecuado puede provocar las heridas. Apagar el interruptor principal y esperar 5 minutos antes de abrir esta cubierta.</p>	<p>ラベルカンデン6カコク LABEL ELECTRICAL SHOCK 36X150</p>	<p>36 X 150</p>	<p>SB8096-001</p>
 <p>⚠ PERIGO A tensão é perigosa e pode causar lesões. Desligar a corrente eléctrica e esperar pelo menos 5 minutos antes de abrir esta tampa.</p>	<p>ラベルカンデン24X96 LABEL ELECTRICAL SHOCK 24X96</p>	<p>24 X 96</p>	<p>SC6835-001</p>
 <p>⚠ CAUTION Take care not to let the liquids come into contact with your eyes or onto your skin, otherwise inflammation can result.</p> <p>⚠ ACHTUNG Vermeiden Sie den Kontakt der Flüssigkeiten mit Augen und Haut, sonst können diese gereizt werden.</p> <p>⚠ ATTENTION Veuillez à ne pas laisser ces liquides être en contact avec les yeux ou la peau, car ceci pourrait entraîner une inflammation.</p> <p>⚠ ATENCIÓN Tome el cuidado para no permitir que los líquidos toquen los ojos ni en la piel, de otro modo inflamación puede resultar.</p> <p>⚠ ATTENZIONE Evitare il contatto di questi liquidi con gli occhi e con la pelle poiché potrebbero creare infiammazioni.</p> <p>⚠ 注意 炎症を起こす可能性がある。インクなどの液体類が目や皮膚に付かないようにすること。</p> <p>⚠ CUIDADO Tome cuidado para não deixar que os líquidos entrem em contato com os olhos ou a pele, caso contrário, poderá ocorrer inflamação.</p>	<p>ラベルメノケガ LABEL EYE INJURY</p>	<p>170 X 90</p>	<p>SC1325-101</p>

Wa2. 警告ラベル / Warning labels

警告ラベル / Warning labels	品名 / Name of parts	Size(mm)	Code																																																												
	<p>ラベルメノケガ LABEL EYE INJURY</p>	<p>80 X 50</p>	<p>SC1615-001</p>																																																												
<table border="1" data-bbox="169 551 683 1368"> <tr> <td data-bbox="169 551 419 786"> <p>CAUTION</p>  <p>Do not drink the liquids under any circumstances, as they can cause vomiting and diarrhea. Take care not to let the liquids come into contact with your eyes or onto your skin, otherwise inflammation can result. Keep the liquids out of the reach of children.</p> </td> <td data-bbox="419 551 683 725"> <p>VORSICHT</p> <p>Bitte trinken Sie nicht die Flüssigkeiten, da die Gefahr von Erbrechen und Durchfall besteht. Vermeiden Sie den Kontakt der Flüssigkeiten mit Augen und Haut, sonst können diese gereizt werden. Halten Sie die Flüssigkeiten von Kindern fern.</p> </td> </tr> <tr> <td data-bbox="169 786 419 994"> <p>ATTENTION</p> <p>Ne pas avaler les liquides d'aucune manière, car ceci pourrait entraîner vomissements et diarrhée. Veuillez à ne pas laisser ces liquides être en contact avec les yeux ou la peau, car ceci pourrait entraîner une inflammation. Maintenez les liquides hors de portée des enfants.</p> </td> <td data-bbox="419 725 683 900"> <p>ATENCIÓN</p> <p>No tome los líquidos en cualquier caso, como pueden causar vomitar y diarrea. Tome el cuidado para no permitir que los líquidos toquen los ojos ni en la piel, de otro modo inflamación puede resultar. Mantenga los líquidos fuera del alcance de niños.</p> </td> </tr> <tr> <td data-bbox="169 994 419 1173"> <p>ATTENZIONE</p> <p>Non bere per nessun motivo i liquidi poiché possono causare vomito e diarrea. Evitare il contatto di questi liquidi con gli occhi e con la pelle poiché potrebbero creare infiammazioni. Conservare i liquidi lontano dalla portata dei bambini.</p> </td> <td data-bbox="419 900 683 1039"> <p>注意</p> <p>下痢・おう吐する可能性がある。インクなどの液体類を飲まないこと。炎症を起こす可能性がある。インクなどの液体類が目や皮膚に付かないようにすること。子供の手の届かないところに置くこと。</p> </td> </tr> <tr> <td data-bbox="169 1173 419 1368"> <p>CUIDADO</p> <p>Não beba os líquidos sob nenhuma circunstância, pois eles podem causar vômitos e diarreia. Tome cuidado para não deixar que os líquidos entrem em contato com os olhos ou a pele, caso contrário, poderá ocorrer inflamação. Mantenha os líquidos fora do alcance das crianças.</p> </td> <td data-bbox="419 1039 683 1368"> <p>注意</p>  <p>有可能导致腹泻、呕吐。请勿饮用油墨等液体类。有可能引发炎症。注意油墨等液体类不要飞溅到眼中或皮肤上。请放置在儿童无法触及的地方。</p> <ul style="list-style-type: none"> ■ Deposit in compliance with your local regulations. ■ Gebrauchte es gemäß örtlichen Richtlinien entsorgen. ■ Jetez conformément à la réglementation locale en vigueur. ■ Deseche siguiendo la normativa local. ■ Smaltire in conformità alle normative locali. ■ Deposite em conformidade com os regulamentos locais. ■ 地域の法令に従って廃棄してください。 ■ 应按照当地法律废弃。 </td> </tr> </table>	<p>CAUTION</p>  <p>Do not drink the liquids under any circumstances, as they can cause vomiting and diarrhea. Take care not to let the liquids come into contact with your eyes or onto your skin, otherwise inflammation can result. Keep the liquids out of the reach of children.</p>	<p>VORSICHT</p> <p>Bitte trinken Sie nicht die Flüssigkeiten, da die Gefahr von Erbrechen und Durchfall besteht. Vermeiden Sie den Kontakt der Flüssigkeiten mit Augen und Haut, sonst können diese gereizt werden. Halten Sie die Flüssigkeiten von Kindern fern.</p>	<p>ATTENTION</p> <p>Ne pas avaler les liquides d'aucune manière, car ceci pourrait entraîner vomissements et diarrhée. Veuillez à ne pas laisser ces liquides être en contact avec les yeux ou la peau, car ceci pourrait entraîner une inflammation. Maintenez les liquides hors de portée des enfants.</p>	<p>ATENCIÓN</p> <p>No tome los líquidos en cualquier caso, como pueden causar vomitar y diarrea. Tome el cuidado para no permitir que los líquidos toquen los ojos ni en la piel, de otro modo inflamación puede resultar. Mantenga los líquidos fuera del alcance de niños.</p>	<p>ATTENZIONE</p> <p>Non bere per nessun motivo i liquidi poiché possono causare vomito e diarrea. Evitare il contatto di questi liquidi con gli occhi e con la pelle poiché potrebbero creare infiammazioni. Conservare i liquidi lontano dalla portata dei bambini.</p>	<p>注意</p> <p>下痢・おう吐する可能性がある。インクなどの液体類を飲まないこと。炎症を起こす可能性がある。インクなどの液体類が目や皮膚に付かないようにすること。子供の手の届かないところに置くこと。</p>	<p>CUIDADO</p> <p>Não beba os líquidos sob nenhuma circunstância, pois eles podem causar vômitos e diarreia. Tome cuidado para não deixar que os líquidos entrem em contato com os olhos ou a pele, caso contrário, poderá ocorrer inflamação. Mantenha os líquidos fora do alcance das crianças.</p>	<p>注意</p>  <p>有可能导致腹泻、呕吐。请勿饮用油墨等液体类。有可能引发炎症。注意油墨等液体类不要飞溅到眼中或皮肤上。请放置在儿童无法触及的地方。</p> <ul style="list-style-type: none"> ■ Deposit in compliance with your local regulations. ■ Gebrauchte es gemäß örtlichen Richtlinien entsorgen. ■ Jetez conformément à la réglementation locale en vigueur. ■ Deseche siguiendo la normativa local. ■ Smaltire in conformità alle normative locali. ■ Deposite em conformidade com os regulamentos locais. ■ 地域の法令に従って廃棄してください。 ■ 应按照当地法律废弃。 	<p>ハイエキラベル 145X90 LABEL WASTE INK 145X90</p>	<p>145 X 90</p>	<p>SB9802-201</p>																																																				
<p>CAUTION</p>  <p>Do not drink the liquids under any circumstances, as they can cause vomiting and diarrhea. Take care not to let the liquids come into contact with your eyes or onto your skin, otherwise inflammation can result. Keep the liquids out of the reach of children.</p>	<p>VORSICHT</p> <p>Bitte trinken Sie nicht die Flüssigkeiten, da die Gefahr von Erbrechen und Durchfall besteht. Vermeiden Sie den Kontakt der Flüssigkeiten mit Augen und Haut, sonst können diese gereizt werden. Halten Sie die Flüssigkeiten von Kindern fern.</p>																																																														
<p>ATTENTION</p> <p>Ne pas avaler les liquides d'aucune manière, car ceci pourrait entraîner vomissements et diarrhée. Veuillez à ne pas laisser ces liquides être en contact avec les yeux ou la peau, car ceci pourrait entraîner une inflammation. Maintenez les liquides hors de portée des enfants.</p>	<p>ATENCIÓN</p> <p>No tome los líquidos en cualquier caso, como pueden causar vomitar y diarrea. Tome el cuidado para no permitir que los líquidos toquen los ojos ni en la piel, de otro modo inflamación puede resultar. Mantenga los líquidos fuera del alcance de niños.</p>																																																														
<p>ATTENZIONE</p> <p>Non bere per nessun motivo i liquidi poiché possono causare vomito e diarrea. Evitare il contatto di questi liquidi con gli occhi e con la pelle poiché potrebbero creare infiammazioni. Conservare i liquidi lontano dalla portata dei bambini.</p>	<p>注意</p> <p>下痢・おう吐する可能性がある。インクなどの液体類を飲まないこと。炎症を起こす可能性がある。インクなどの液体類が目や皮膚に付かないようにすること。子供の手の届かないところに置くこと。</p>																																																														
<p>CUIDADO</p> <p>Não beba os líquidos sob nenhuma circunstância, pois eles podem causar vômitos e diarreia. Tome cuidado para não deixar que os líquidos entrem em contato com os olhos ou a pele, caso contrário, poderá ocorrer inflamação. Mantenha os líquidos fora do alcance das crianças.</p>	<p>注意</p>  <p>有可能导致腹泻、呕吐。请勿饮用油墨等液体类。有可能引发炎症。注意油墨等液体类不要飞溅到眼中或皮肤上。请放置在儿童无法触及的地方。</p> <ul style="list-style-type: none"> ■ Deposit in compliance with your local regulations. ■ Gebrauchte es gemäß örtlichen Richtlinien entsorgen. ■ Jetez conformément à la réglementation locale en vigueur. ■ Deseche siguiendo la normativa local. ■ Smaltire in conformità alle normative locali. ■ Deposite em conformidade com os regulamentos locais. ■ 地域の法令に従って廃棄してください。 ■ 应按照当地法律废弃。 																																																														
<table border="1" data-bbox="159 1462 691 2056"> <tr> <td data-bbox="196 1487 264 1554">  </td> <td data-bbox="272 1487 341 1554">  </td> <td data-bbox="349 1487 418 1554">  </td> <td data-bbox="426 1487 494 1554">  </td> <td data-bbox="502 1487 571 1554">  </td> <td data-bbox="579 1487 647 1554">  </td> </tr> <tr> <td colspan="6" data-bbox="196 1563 655 1581"> <p>Use Before</p> </td> </tr> <tr> <td colspan="6" data-bbox="196 1704 655 1733"> <p>CAUTION</p> </td> </tr> <tr> <td colspan="6" data-bbox="196 1742 655 1787">  </td> </tr> <tr> <td colspan="6" data-bbox="196 1796 655 1827"> <p>Take care not to let the liquids come into contact with your eyes or onto your skin, otherwise inflammation can result. Keep the liquids out of the reach of children.</p> </td> </tr> <tr> <td colspan="6" data-bbox="196 1836 655 1868"> <p>Do not drink the liquids under any circumstances, as they can cause vomiting and diarrhea.</p> </td> </tr> <tr> <td colspan="6" data-bbox="196 1877 655 1908"> <p>Opening the seal cap with bare hands may cause injury. Use pliers to open the seal cap.</p> </td> </tr> <tr> <td colspan="6" data-bbox="196 1917 655 1948"> <p>Heavy drum could cause injury or backache. Do not lift or move the drum without mechanical assistance.</p> </td> </tr> <tr> <td colspan="6" data-bbox="196 1957 655 1989"> <p>NOTE</p> </td> </tr> <tr> <td colspan="6" data-bbox="196 1998 655 2029"> <p>Deposite in compliance with your local regulations. Do not overtighten.</p> </td> </tr> </table>							<p>Use Before</p>						<p>CAUTION</p>												<p>Take care not to let the liquids come into contact with your eyes or onto your skin, otherwise inflammation can result. Keep the liquids out of the reach of children.</p>						<p>Do not drink the liquids under any circumstances, as they can cause vomiting and diarrhea.</p>						<p>Opening the seal cap with bare hands may cause injury. Use pliers to open the seal cap.</p>						<p>Heavy drum could cause injury or backache. Do not lift or move the drum without mechanical assistance.</p>						<p>NOTE</p>						<p>Deposite in compliance with your local regulations. Do not overtighten.</p>						<p>ラベルマエショリ 180 X 160 LABEL PRETREAT P2H 180 X 160</p>	<p>180 X 160</p>	<p>SC2484-001</p>
																																																															
<p>Use Before</p>																																																															
<p>CAUTION</p>																																																															
																																																															
<p>Take care not to let the liquids come into contact with your eyes or onto your skin, otherwise inflammation can result. Keep the liquids out of the reach of children.</p>																																																															
<p>Do not drink the liquids under any circumstances, as they can cause vomiting and diarrhea.</p>																																																															
<p>Opening the seal cap with bare hands may cause injury. Use pliers to open the seal cap.</p>																																																															
<p>Heavy drum could cause injury or backache. Do not lift or move the drum without mechanical assistance.</p>																																																															
<p>NOTE</p>																																																															
<p>Deposite in compliance with your local regulations. Do not overtighten.</p>																																																															

索引 / Index

CODE	REF.NO	Page	CODE	REF.NO	Page	CODE	REF.NO	Page	CODE	REF.NO	Page
008400807	K - 6	29	SC0032001	Co - 22	31	SC3527001	C - 9	9	SC4154001	G2 - 20	23
018300636	F2 - 21	17	SC0041002	Wa1	34	SC3542001	Co - 41	31	SC4155001	G2 - 21	23
0A5300806	F2 - 11	17	SC0202001	E - 14	13	SC3544001	C - 10	9	SC4156101	G2 - 22	23
	F3 - 22	19		K - 15	29	SC3545001	J - 21	27	SC4157101	G2 - 23	23
	F3 - 28	19	SC0433001	F1 - 15	15	SC3548001	J - 22	27	SC4158101	G2 - 24	23
0A5301206	F2 - 6	17	SC0434001	F1 - 16	15	SC3573001	B - 4	7	SC4159101	G2 - 25	23
A60014001	J - 17	27	SC0544001	F1 - 13	15	SC3585001	C - 3	9	SC4160101	G2 - 26	23
D00N32001	J - 9	27	SC0937001	E - 46	13	SC3591001	E - 27	13	SC4161101	G2 - 27	23
GC60GR09L	Co - 12	31	SC1325101	Wa1	34	SC3593001	F1 - 20	15	SC4162101	G2 - 28	23
GC60OR09L	Co - 11	31	SC1417001	E - 18	13	SC3596001	F1 - 22	15	SC4163101	G2 - 29	23
GCX-4P05	Co - 15	31	SC1615001	Wa2	35		F1 - 28	15	SC4164101	G2 - 30	23
GCX-4P20	Co - 16	31	SC1643001	F1 - 26	15	SC3598001	F1 - 23	15	SC4165101	G2 - 31	23
GCX-4P2H	Co - 17	31	SC1646101	F1 - 10	15	SC3600001	F1 - 24	15	SC4166101	G2 - 32	23
GCX-4PS05	Co - 18	31	SC1647101	E - 20	13	SC3601001	F1 - 5	15	SC4167101	G2 - 33	23
GCX-4PS20	Co - 19	31		F1 - 11	15	SC3623001	F1 - 25	15	SC4168101	G2 - 34	23
GCX-4PS2H	Co - 20	31	SC1680001	F1 - 45	15	SC3624001	F1 - 27	15	SC4169101	G2 - 35	23
GCX-6C09L-1	Co - 5	31	SC1695001	F1 - 30	15	SC3666001	F1 - 29	15	SC4170101	G2 - 36	23
GCX-6C18L-1	Co - 6	31		F3 - 14	19	SC3667001	F1 - 31	15	SC4171201	G2 - 37	23
GCX-6E09L	Co - 13	31		F3 - 21	19	SC3670001	F1 - 32	15	SC4172201	G2 - 38	23
GCX-6E18L	Co - 14	31	SC2484001	Wa2	35	SC3692001	F1 - 14	15	SC4173101	G2 - 39	23
GCX-6K09L-1	Co - 1	31	SC2499001	C - 1	9	SC3693101	E - 30	13	SC4174101	G2 - 40	23
GCX-6K18L-1	Co - 2	31	SC2525001	C - 5	9	SC3694101	E - 31	13	SC4175101	G2 - 41	23
GCX-6M09L-1	Co - 3	31	SC2526001	C - 6	9	SC3715001	E - 17	13	SC4176101	G2 - 42	23
GCX-6M18L-1	Co - 4	31	SC2527001	C - 7	9	SC3716001	E - 28	13	SC4177101	G2 - 43	23
GCX-6W09L	Co - 9	31	SC2543001	D - 1	11	SC3717101	E - 29	13	SC4178101	G2 - 44	23
GCX-6W18L	Co - 10	31	SC2546001	D - 2	11	SC3718101	E - 32	13	SC4180001	D - 19	11
GCX-6Y09L-1	Co - 7	31	SC2551101	D - 3	11	SC3720101	E - 33	13		H - 18	25
GCX-6Y18L-1	Co - 8	31	SC2555101	D - 6	11	SC3721001	E - 34	13	SC4181001	G2 - 45	23
LG2239001	C - 2	9	SC2564001	D - 26	11	SC3722101	E - 35	13	SC4182001	D - 20	11
	C - 4	9	SC2567101	D - 27	11	SC3723101	E - 36	13		G2 - 46	23
	D - 5	11	SC2576001	D - 22	11	SC3724101	E - 37	13	SC4183001	G2 - 47	23
	E - 9	13	SC2589001	D - 4	11	SC3725001	E - 38	13	SC4184001	G2 - 48	23
	F1 - 3	15	SC2674001	Co - 53	33	SC3726001	E - 23	13		H - 20	25
	F3 - 19	19	SC3027001	E - 10	13	SC3774001	E - 24	13	SC4185101	H - 19	25
	F3 - 24	19	SC3058001	Co - 33	31	SC3788001	Co - 55	33	SC4186001	J - 15	27
LM9291001	B - 9	7	SC3060001	Co - 37	31	SC3815001	E - 21	13	SC4187101	H - 15	25
	D - 23	11	SC3080001	C - 8	9	SC3818001	E - 22	13	SC4188101	H - 16	25
S03607001	D - 7	11	SC3109001	J - 2	27	SC3866001	H - 14	25	SC4190101	H - 6	25
S55479001	K - 7	29		K - 5	29	SC3962001	H - 2	25	SC4191101	H - 7	25
SB2017001	D - 8	11	SC3125001	A - 1	5	SC3963001	H - 3	25	SC4192101	H - 8	25
SB2399001	J - 6	27	SC3126001	A - 2	5	SC3967001	H - 12	25	SC4193101	H - 9	25
SB2400101	J - 1	27	SC3188001	F1 - 12	15	SC3968001	H - 13	25	SC4194101	H - 17	25
	K - 4	29	SC3202001	K - 1	29	SC3970001	H - 22	25	SC4195101	D - 24	11
SB4606001	K - 2	29	SC3237201	D - 9	11	SC3971001	H - 21	25	SC4196101	G2 - 49	23
SB4746001	J - 8	27	SC3240101	G1 - 1	21	SC4135101	G2 - 1	23	SC4197101	G2 - 50	23
SB5346101	F1 - 2	15	SC3246101	D - 11	11	SC4136101	G2 - 2	23	SC4198001	F3 - 29	19
SB6235001	E - 11	13	SC3256101	D - 10	11	SC4137101	G2 - 3	23	SC4199001	F3 - 30	19
SB6925001	K - 14	29		G1 - 3	21	SC4138101	G2 - 4	23	SC4200001	F3 - 31	19
SB7001201	Co - 30	31	SC3259101	J - 10	27	SC4139101	G2 - 5	23	SC4201001	F3 - 32	19
SB7002101	Co - 31	31	SC3262001	D - 21	11	SC4140101	G2 - 6	23	SC4202001	F3 - 33	19
SB7008001	Co - 21	31	SC3268001	J - 7	27	SC4141101	G2 - 7	23	SC4203001	F3 - 34	19
SB7093001	F2 - 15	17	SC3271101	J - 11	27	SC4142101	G2 - 8	23	SC4206101	F1 - 33	15
SB7178001	F3 - 20	19	SC3272101	J - 12	27	SC4143101	G2 - 9	23	SC4207101	F1 - 34	15
	F3 - 25	19	SC3273101	J - 13	27	SC4144101	G2 - 10	23	SC4208101	F1 - 35	15
SB7680001	F1 - 21	15	SC3274101	J - 14	27	SC4145101	G2 - 11	23	SC4209101	F1 - 36	15
	F3 - 15	19	SC3324001	E - 6	13	SC4146101	G2 - 12	23	SC4210101	F1 - 37	15
SB8096001	Wa1	34	SC3340001	F2 - 8	17	SC4147101	G2 - 13	23	SC4211101	F1 - 38	15
SB9760201	E - 19	13		Co - 61	33	SC4148101	G2 - 14	23	SC4212101	F1 - 39	15
	F1 - 4	15	SC3355001	F2 - 1	17	SC4149101	G2 - 15	23	SC4213101	F1 - 40	15
	F1 - 7	15		Co - 62	33	SC4150001	G2 - 16	23	SC4214101	F1 - 41	15
	F1 - 9	15	SC3445001	J - 19	27	SC4151001	G2 - 17	23	SC4215101	F1 - 42	15
SB9802201	Wa2	35	SC3451101	Co - 39	31	SC4152101	G2 - 18	23	SC4216101	F1 - 43	15
SB9937001	E - 26	13	SC3457101	J - 20	27	SC4153001	G2 - 19	23	SC4217101	F1 - 44	15

CODE	REF.NO	Page	CODE	REF.NO	Page	CODE	REF.NO	Page	CODE	REF.NO	Page
SC4219101	B - 6	7	SC5073001	F1 - 19	15	SC6136101	Co - 42	31			
SC4220101	B - 7	7		F2 - 4	17	SC6137101	Co - 43	31			
SC4221001	B - 8	7		F3 - 12	19	SC6138101	Co - 44	31			
SC4226101	C - 11	9		F3 - 27	19	SC6139101	Co - 45	31			
SC4227001	C - 12	9	SC5074001	F1 - 17	15	SC6156001	Co - 47	31			
SC4228101	C - 13	9		F2 - 3	17	SC6157001	Co - 48	31			
SC4229101	C - 14	9		F3 - 26	19	SC6158001	Co - 49	31			
SC4230101	A - 3	5	SC5077001	F3 - 16	19	SC6159001	Co - 50	31			
SC4231101	A - 4	5	SC5080001	F1 - 1	15	SC6173001	E - 48	13			
SC4232001	D - 12	11	SC5081001	F1 - 8	15	SC6178001	E - 49	13			
SC4233001	D - 28	11	SC5082001	F1 - 18	15	SC6835001	Wa1	34			
SC4234001	D - 13	11	SC5097001	E - 39	13	SC6885001	F1 - 46	15			
SC4238001	D - 14	11	SC5098001	E - 40	13	SC6886001	F1 - 47	15			
SC4239001	D - 29	11	SC5099001	E - 41	13	SC6917001	E - 52	13			
SC4240001	D - 15	11	SC5100001	E - 42	13	SC7129001	H - 4	25			
SC4244001	D - 16	11	SC5101001	E - 43	13	SC7200001	F2 - 24	17			
SC4245001	D - 17	11	SC5102001	E - 44	13	SC7210001	F2 - 22	17			
SC4246001	D - 18	11	SC5103001	F3 - 35	19	SC7212001	H - 1	25			
SC4250101	J - 16	27	SC5104001	F3 - 36	19	SC7217001	E - 16	13			
SC4253001	J - 3	27	SC5105001	F3 - 37	19	SC7352001	F2 - 9	17			
SC4254001	J - 4	27	SC5106001	F1 - 48	15	SC7354001	F2 - 25	17			
SC4258001	J - 18	27	SC5107001	F1 - 49	15	SC7355001	F2 - 26	17			
SC4263101	G1 - 2	21	SC5108001	F1 - 50	15	SC7356001	F2 - 27	17			
SC4265001	H - 10	25	SC5109001	G2 - 51	23	SC7357001	F2 - 28	17			
SC4266001	H - 11	25	SC5110001	G2 - 52	23	SC7358001	F2 - 23	17			
SC4267001	H - 5	25	SC5111001	G2 - 53	23	SC7409001	E - 45	13			
SC4549001	K - 12	29	SC5112001	G2 - 54	23	SC7410001	E - 1	13			
SC4577001	Co - 35	31	SC5113001	G2 - 55	23	SC7413001	E - 2	13			
SC4591001	K - 3	29	SC5114001	G2 - 56	23	SC7415001	E - 3	13			
SC4713001	E - 15	13	SC5115001	G2 - 57	23	SC7418001	D - 25	11			
SC4726001	E - 12	13	SC5116001	G2 - 58	23		K - 8	29			
SC4727001	E - 25	13	SC5117001	G2 - 59	23		Co - 27	31			
SC4730101	Wa1	34	SC5118001	G2 - 60	23	SC7419001	K - 17	29			
SC4731001	E - 13	13	SC5129001	F2 - 12	17		Co - 25	31			
SC4870101	Co - 32	31	SC5130001	F2 - 13	17	SC7420001	K - 16	29			
SC4871101	Co - 34	31	SC5137201	J - 5	27		Co - 24	31			
SC4872101	Co - 36	31	SC5138201	Co - 54	33	SC7421001	Co - 23	31			
SC4873101	Co - 38	31	SC5139001	F2 - 5	17	SC7423001	E - 47	13			
SC4874001	Co - 40	31	SC5140001	F2 - 10	17		Co - 26	31			
SC4907001	E - 7	13	SC5141001	F2 - 14	17	SC7424001	E - 4	13			
SC4908001	E - 8	13	SC5142001	F2 - 16	17	SC7426001	E - 5	13			
SC4945001	K - 13	29	SC5143001	F2 - 19	17						
SC4946001	E - 53	13	SC5144001	F3 - 1	19						
	E - 54	13	SC5145001	F3 - 2	19						
	K - 10	29	SC5146001	F3 - 3	19						
	K - 11	29	SC5147001	F3 - 4	19						
	Co - 28	31	SC5148001	F3 - 5	19						
SC4971001	F2 - 2	17	SC5149001	F3 - 6	19						
SC4975101	F2 - 20	17	SC5152001	F3 - 7	19						
SC4976001	F3 - 11	19	SC5153001	F3 - 8	19						
SC4977301	F3 - 18	19	SC5154001	F3 - 9	19						
SC4979301	F3 - 23	19	SC5155001	F3 - 10	19						
SC5017001	F2 - 7	17	SC5156001	F2 - 17	17						
	F3 - 13	19	SC5157001	F2 - 18	17						
	F3 - 17	19	SC5193001	E - 50	13						
SC5064101	B - 1	7	SC5385001	F1 - 6	15						
SC5065001	B - 2	7	SC5509001	E - 51	13						
SC5066001	B - 3	7	SC5514001	K - 9	29						
	Co - 29	31	SC6043001	Co - 56	33						
SC5067201	B - 5	7	SC6044001	Co - 57	33						
SC5068101	Co - 46	31	SC6045001	Co - 58	33						
SC5070001	Co - 51	31	SC6046001	Co - 60	33						
SC5071001	Co - 52	33	SC6047001	Co - 59	33						

brother

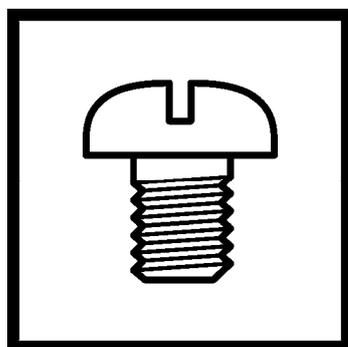

パーツブック
PARTS BOOK

ブラザー工業株式会社 <https://www.brother.co.jp/>
〒448-0803 刈谷市野田町北地蔵山1番地5 TEL:0566-25-5031
BROTHER INDUSTRIES, LTD. <https://www.brother.com>
1-5, Kitajizoyama, Noda-cho, Kariya 448-0803, Japan.

©2022 Brother Industries, Ltd. All Rights Reserved.

GT60SB
I2121780F EN
2022.12.F (1)