

GTX-4

GARMENT PRINTER

For Macintosh Instruction Manual

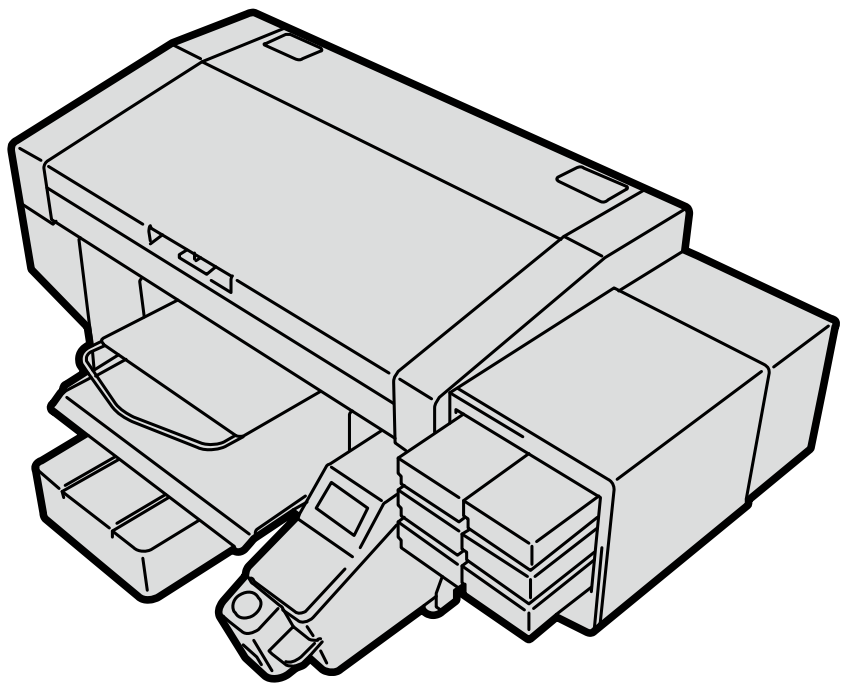

Please be sure to read this manual before using this product.
Keep this manual in a safe place for future use.

1. Before Using Your Printer for the First Time	1-1
1-1. Be sure to read the following notes before using the printer	1-1
1-2. Operating environment	1-2
2. Connection of printer with Macintosh PC (Apple Computer)	2-1
2-1. Installing printer driver onto your PC	2-1
2-2. Connecting the printer to your PC via a USB 2.0 cable	2-2
2-3. Connecting the printer to your PC via a LAN cable	2-4
3. Print data transmission by means of Brother GTX-4 FileOutput	3-1

1-1. Be sure to read the following notes before using the printer

Keep in mind the following points before using the application:

Precautions for proper use

- The steps for printer setup and maintenance are basically the same as for Windows PCs. Refer to the Instruction Manual.
To start "GTX-4 Maintenance" on your Macintosh, select [Finder] > [Applications] > "GTX-4 Maintenance".
- The steps to update the firmware of the printer are basically the same as for Windows PCs. Refer to the Instruction Manual.
To start "GTX-4 Firmware Update" on your Macintosh, select [Finder] > [Applications] > "GTX-4 Firmware Update".
- For printing out an image data that contains the transparent information, please use the Graphix Lab for PNG image.
To start Graphix Lab on your Macintosh, select [Finder] > [Applications] > "Graphix Lab.app".
- The steps to use Useful Tools are basically the same as for Windows PCs. Refer to the Instruction Manual.
To start "Useful Tools" on your Macintosh, select [Finder] > [Applications] > "Useful Tools".
- To upgrade the driver, delete the USB and LAN printers and perform the steps described in "2-2. Connecting the printer to your PC via a USB 2.0 cable >>P2-2" and "2-3. Connecting the printer to your PC via a LAN cable >>P2-4".
Presets created on the [Print Settings] screen will not be inherited.
(It is not necessary to delete "Brother GTX-4 FileOutput". Presets will be inherited to "Brother GTX-4 FileOutput".)

About trademarks

The names of operating systems described in the main context of this manual are abbreviated. Product names used in this manual are, in general, trademarks or registered trademarks of their respective developer or manufacture. However, in this manual, the ® marks or TM marks are not used.

Brother logo is registered trademark of Brother Industries, Ltd.

Apple, Macintosh, Mac OS, iOS, OS X, Safari, iPad, iPhone, iPod and iPod touch are registered trademarks of Apple Inc. in the United States of America and other countries.

Microsoft[®], Windows[®] 7, Windows[®] 8.1 and Windows[®] 10 are trademarks and registered trademarks of Microsoft Corporation in the United States of America and other countries.

Other product and company names mentioned herein may be the trademarks or registered trademarks of their respective owners.

Information in this document and the specifications of this product are subject to change without notice.

1-2. Operating environment

Compatible OS	Mac OS X 10.12 Sierra, Mac OS X 10.13 High Sierra
Interface	USB 2.0, LAN (10 BASE-T and 100 BASE-TX), USB flash memory (Please use a FAT32-formatted USB flash memory of which storage capacity is 32 GB or less.)
Min. operating environment	CPU: 2 GHz or better RAM: 4 GB or more
Display resolution	XGA (1024 x 768) or higher

This chapter provides information about the procedures to install the GTX-4 printer driver onto your PC.

If you connect an USB 2.0 cable to your PC after these installation procedures are completed, make your setting by following the procedures described in the "2-2. Connecting the printer to your PC via a USB 2.0 cable >>P.2-2". If you want to perform a network printing, establish a network printing setup in accordance with the "2-3. Connecting the printer to your PC via a LAN cable >>P.2-4".

2-1. Installing printer driver onto your PC

To begin with, onto your PC, install the printer driver for file output, Brother GTX-4 FileOutput.

At this stage, do not connect the printer to your PC yet.

<TIPS>

- You must log into your PC with administrator privileges.

- (1) Activate the PC.
- (2) Complete all of the current sessions.
- (3) Double-click on the "BrotherGTX-4_ver***.pkg" to execute installer.
- (4) Then, the installation procedures will begin. Follow the on-screen instructions to complete the installation.
- (5) After the installation is completed, reactivate the PC.

2-2. Connecting the printer to your PC via a USB 2.0 cable

- (1) With the printer powered on, make a connection of USB 2.0 cable between the printer and your PC.
- (2) From the Apple menu, open the [System Preferences] and click on the [Printers & Scanners].

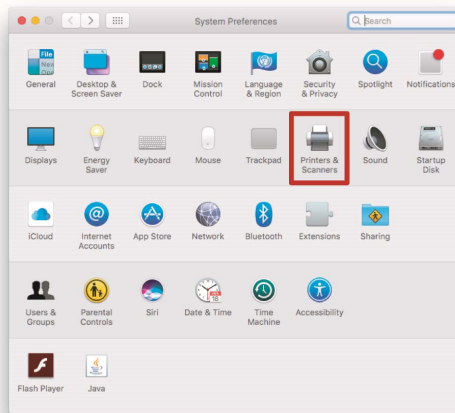

- (3) After that, click the + button in the lower-left corner.

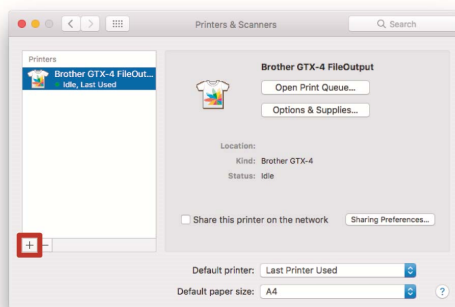

- (4) Select the [Brother GTX-4xx] first, then click on the [Select Software...] of [Use].

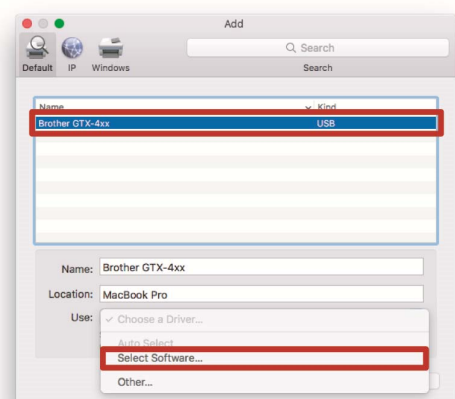

- (5) Select the [Brother GTX-4] and click on the [OK].

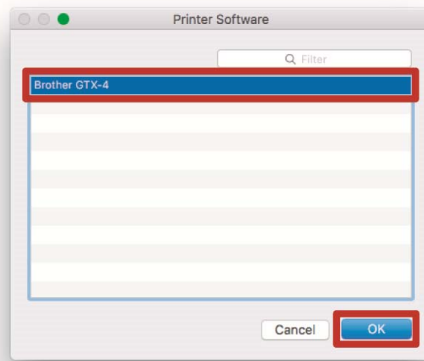

- (6) Then, click [Add].

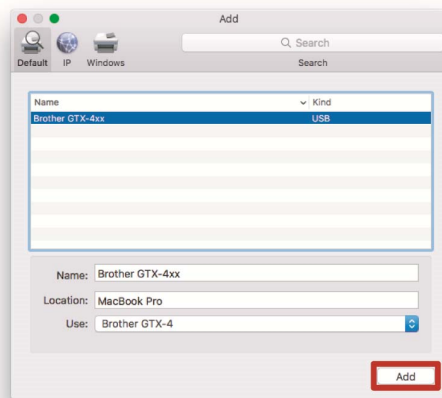

- (7) In the [Default printer], select either [Brother GTX-4xx] or [Brother GTX-4 FileOutput].

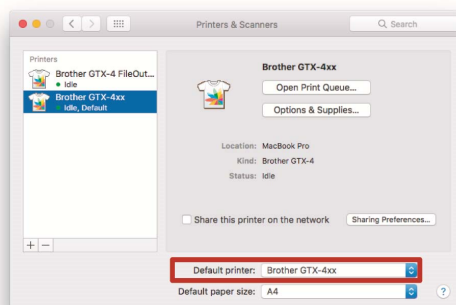

This exits the setting for the USB connection.

2-3. Connecting the printer to your PC via a LAN cable

When you connect your Macintosh to the printer via a LAN cable, configure the IP address settings for the printer, referring to the Instruction Manual.

Subsequently, perform the procedures below to add the printer to your PC.

- (1) Connect your PC with the printer by means of the LAN cable to make a network connection, and power on the printer.

<TIPS>

- For this connection of the LAN cable, secure it in place by means of the cable clamp as required.

- (2) From the Apple menu, open the [System Preferences] and click on the [Printers & Scanners].

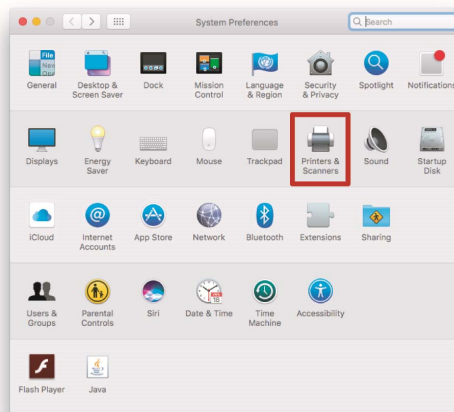

- (3) After that, click the + button in the lower-left corner.

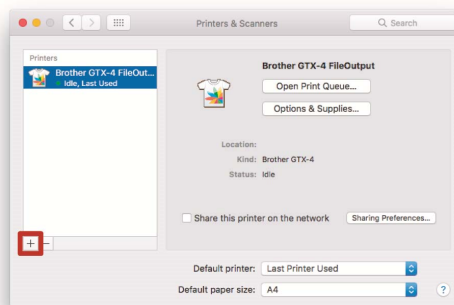

- (4) Select [IP].

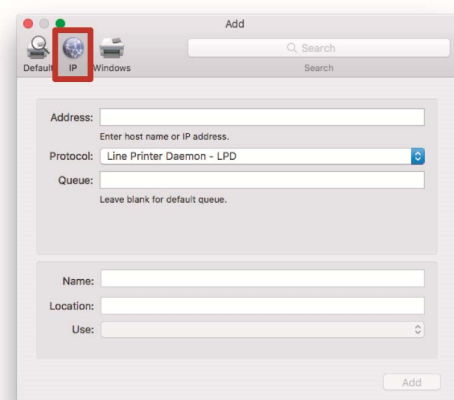

- (5) In the [Address], enter the IP address of the printer you have just set up.
 Select the [Line Printer Daemon - LPD] of [Protocol].
 In the [Queue], type in the word "BINARY_P1".
 Enter the name of the printer in the [Name].
 Click on the [Select Software...] of [Use].

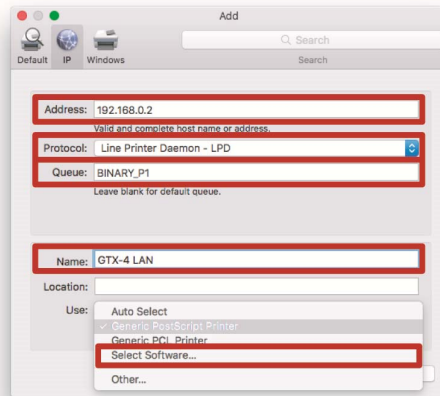

- (6) Select the [Brother GTX-4] and click on the [OK].

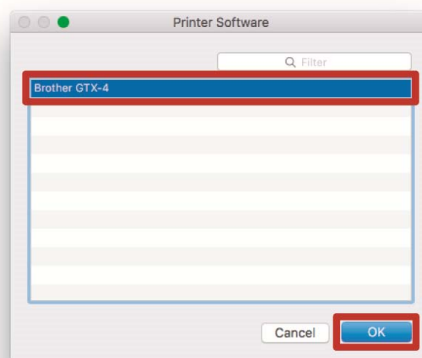

- (7) Then, click [Add].

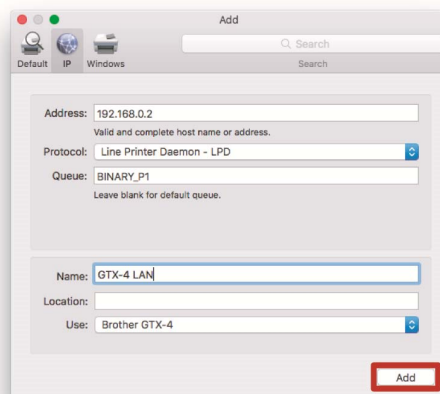

- (8) Then, the current window goes back to the [Printers & Scanners] window into which the GTX-4 printer (LAN) is added.

In the [Default printer], select your desired GTX-4 printer, as required.

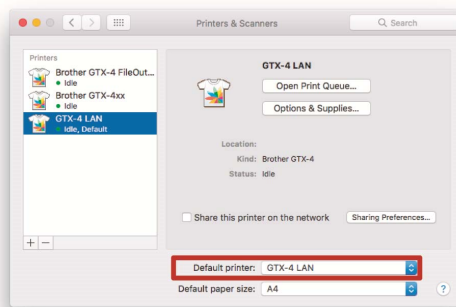

This exits the setting for the LAN connection.

Saving print data to a file

When using the "Brother GTX-4 FileOutput" printer to save print data to a file, be sure to perform the save operation with the "GTX-4 FileViewer" being activated.

If you try to output and save the data to a file without activating the "GTX-4 FileViewer", an error shown below will occur and the file cannot be saved to the system.



<TIPS>

- The procedures to output a file from the "Brother GTX-4 FileOutput" are the same as those for Windows PC. For details, refer to the Instruction Manual.

Transmission of print data

Send such print data that has been saved using the "Brother GTX-4 FileOutput" printer to the printer by performing the procedures mentioned below.

<TIPS>

- The procedures to send the print data are the same as those for Windows PC. For details, refer to the Instruction Manual.

- (1) Double-click on a file with the extension ".arx4" assigned to its filename which has been saved by means of the "Brother GTX-4 FileOutput" printer.
- (2) Subsequently, the "GTX-4 FileViewer" starts working, then, under that condition, click on the [Send to Printer], which results in the file transmission.



*Please note that the contents of this manual may differ slightly from the actual product purchased as a result of product improvements.

BROTHER INDUSTRIES, LTD. <http://www.brother.com/>
1-5, Kitajizoyama, Noda-cho, Kariya 448-0803, Japan.

© 2017, 2018 Brother Industries, Ltd. All Rights Reserved.
This is the original instructions.

GTX-422
I8041246F E
2018.04.F(1)